

## ИГРОВЫЕ КОМПЛЕКСЫ: ИКС, ДИКС, ИКС-БИО, МГН

Благодаря новейшим технологиям, наша продукция обладает высоким качеством и доступной стоимостью.

Все выпускаемые игровые комплексы собираются из готовых модулей. Сборка модулей производится на месте без сварки при помощи резьбовых соединений.



Модульная система игровых комплексов, разработанная нашими специалистами, позволяет конструировать **самые разнообразные площадки** любой конфигурации с любым набором оборудования.

Для защиты металла от коррозии применяется полимерное порошковое покрытие. Для изготовления малых архитектурных форм применяется только влагостойкая фанера, окрашенная яркими, устойчивыми к атмосферным воздействиям красками.

К заказчику оборудование поставляется в разобранном виде. Сборку изделий заказчик может произвести самостоятельно или при помощи нашей монтажной бригады на основании паспорта на изделие и технической документации.



## ИЗГОТОВЛЕНИЕ СКЕЙТ-ПАРКОВ

Неотъемлемой частью технологического процесса производства оборудования для скейт-парков является контрольная сборка и доводка всех элементов конструкции, которая выполняется **высококласными специалистами**.



Данная операция играет важную роль для достижения **наилучшего качества выпускаемой продукции**.

Оборудование проектируется согласно всех СНиПов и ГОСТов, а также имеет сертификат качества, рекомендовано Управлением Комитета Архитектуры для установки в школах, детских садах, жилых дворах и спорткомплексах.



Оборудование разработано на основании следующих нормативных документов Госстандарта России:

- ГОСТ Р 52167-2003 "Оборудование детских игровых площадок. Безопасность конструкции и методы испытаний качелей. Общие требования"
- ГОСТ Р 52168-2003 "Оборудование детских игровых площадок. Безопасность конструкции и методы испытаний горок. Общие требования"
- ГОСТ Р 52169-2003 "Оборудование детских игровых площадок. Безопасность конструкции и методы испытаний. Общие требования"
- ГОСТ Р 52299-2003 "Оборудование детских игровых площадок. Безопасность конструкции и методы испытаний качалок. Общие требования"
- ГОСТ Р 52300-2004 "Оборудование детских игровых площадок. Безопасность конструкции и методы испытаний каруселей. Общие требования"
- ГОСТ Р 52301-2004 "Оборудование детских игровых площадок. Безопасность при эксплуатации. Общие требования"





ДИКС-1.1



горка Н = 500

2+

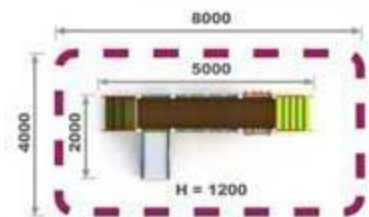

ДИКС-1.2



горка Н = 500

2+

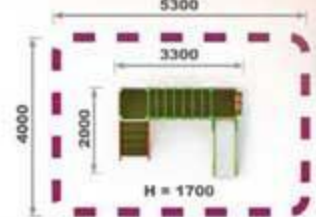

ДИКС-1.3



горка Н = 500

3+

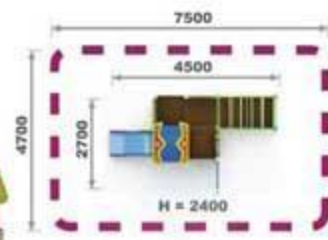

ДИКС-1.4



горки Н = 500, Н=1000

3+

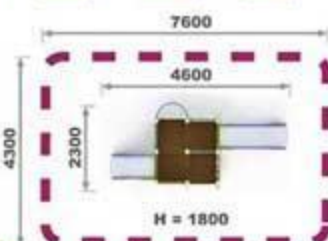





ДИКС-1.5



2+

горка Н = 500

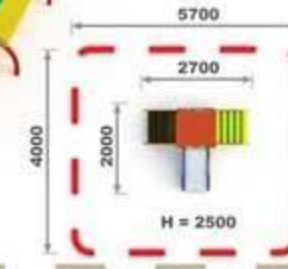

ДИКС-1.6

горка Н = 500



2+

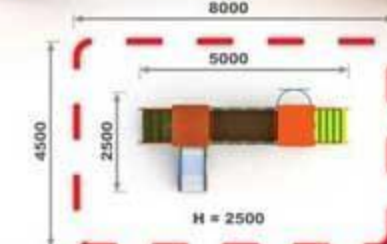

ДИКС-1.7



горки Н = 500, Н=1000

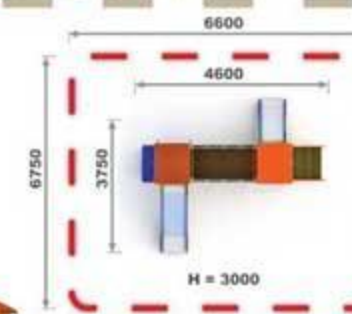

3+



ДИКС-1.8

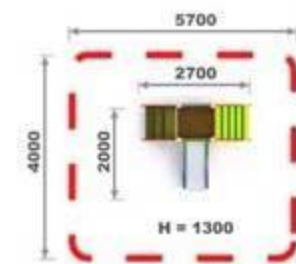

2+

горка Н = 500



ДИКС-1.9

2+

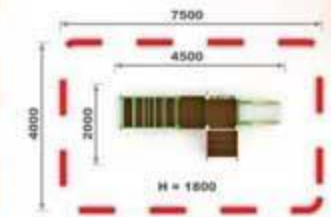

горка Н = 500



ДИКС ИГРОВЫЕ КОМПЛЕКСЫ



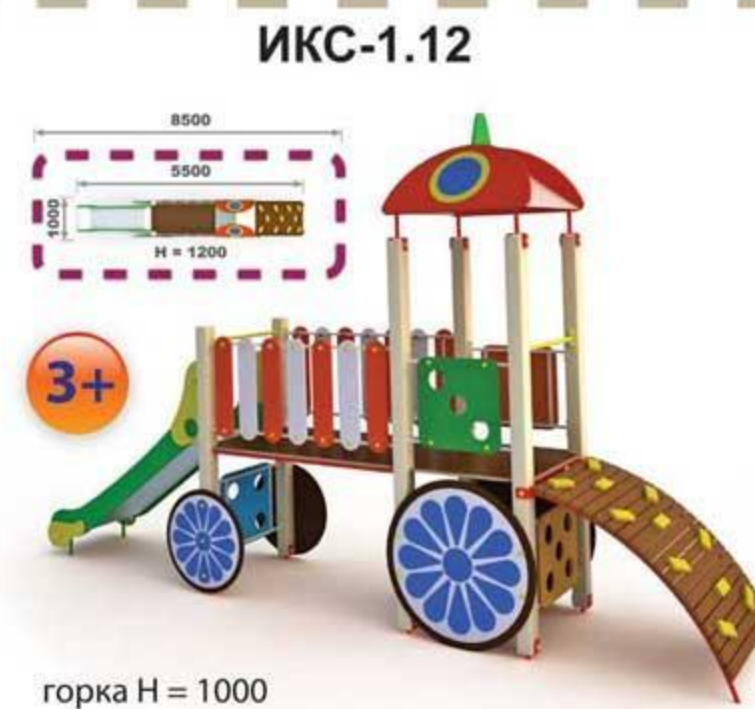



ИКС-1.16



ИКС-1.17

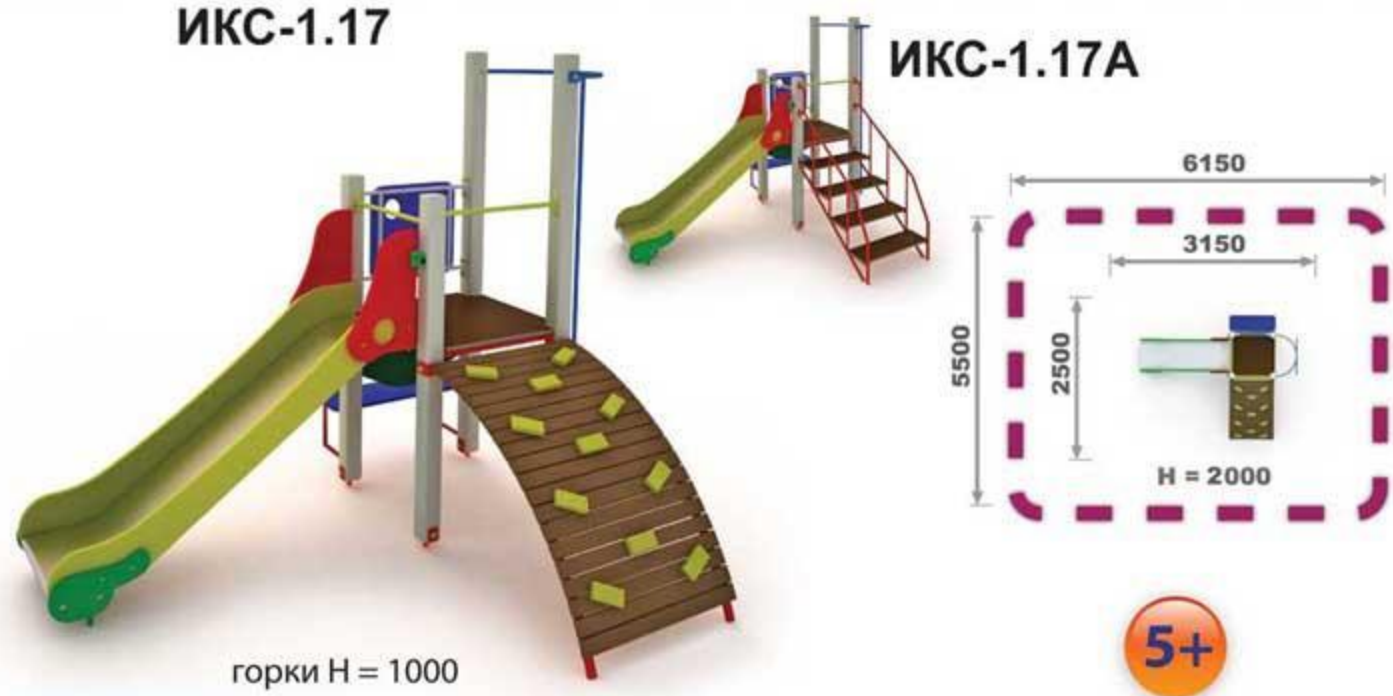

ИКС-1.17А



ИКС-1.24





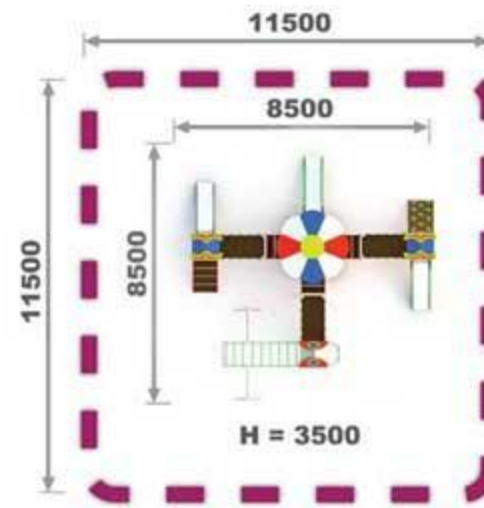

5+

ИКС-1.25



ИКС-1.26

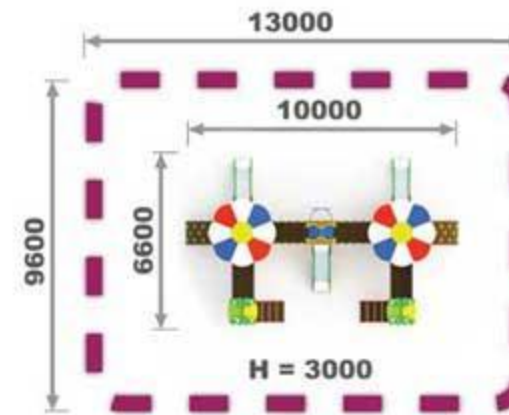

5+



горки H = 1000

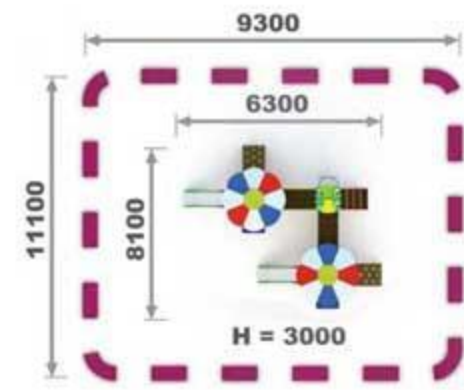

5+

ИКС-1.28



горки H = 1000





ИКС-1.31

горка Н = 1000

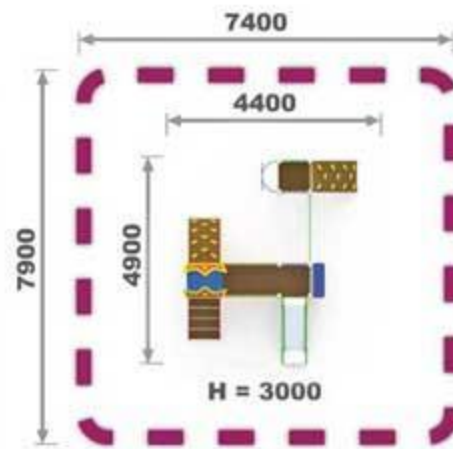

5+



ИКС-1.31

ИКС-1.31



ИКС-1.32

горка Н = 1000

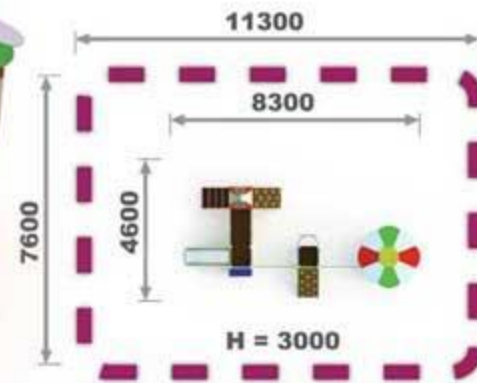

5+



ИКС-1.32

ИКС-1.32



ИКС-1.34

горка Н = 1000

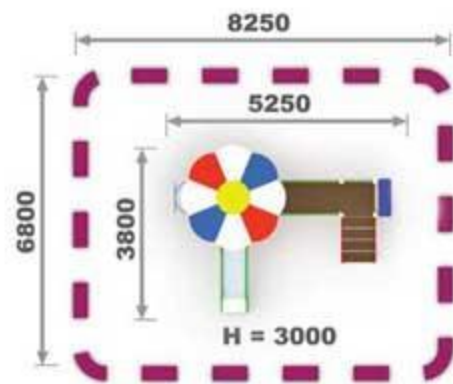

5+



ИКС-1.34

ИКС-1.34







ИКС-1.42

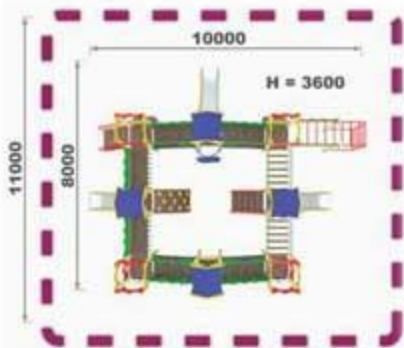

5+

зameк "Нивенро"

горки H=1000, H=1450



ИКС-1.42

зameк "Нивенро"

ИКС-1.43

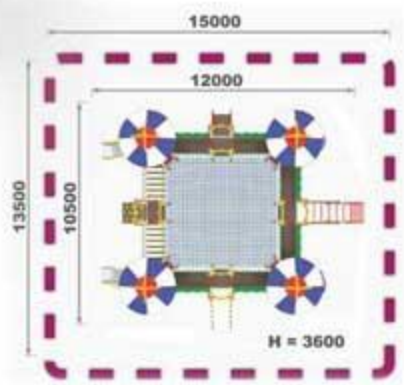

5+

зameк "Версаав"

горки H=1000



ИКС-1.42

ИКС-1.42



ИКС-1.43

КАЧ-1.6

МФ-1.6

МФ-1.74

У-1.5

Д-1.23

КАЧ-1.8



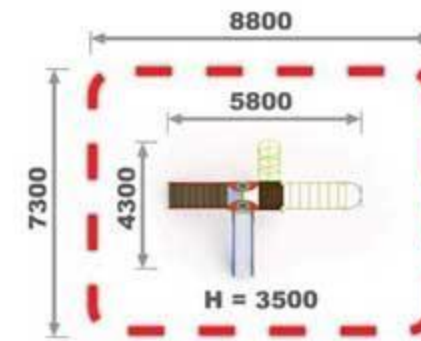
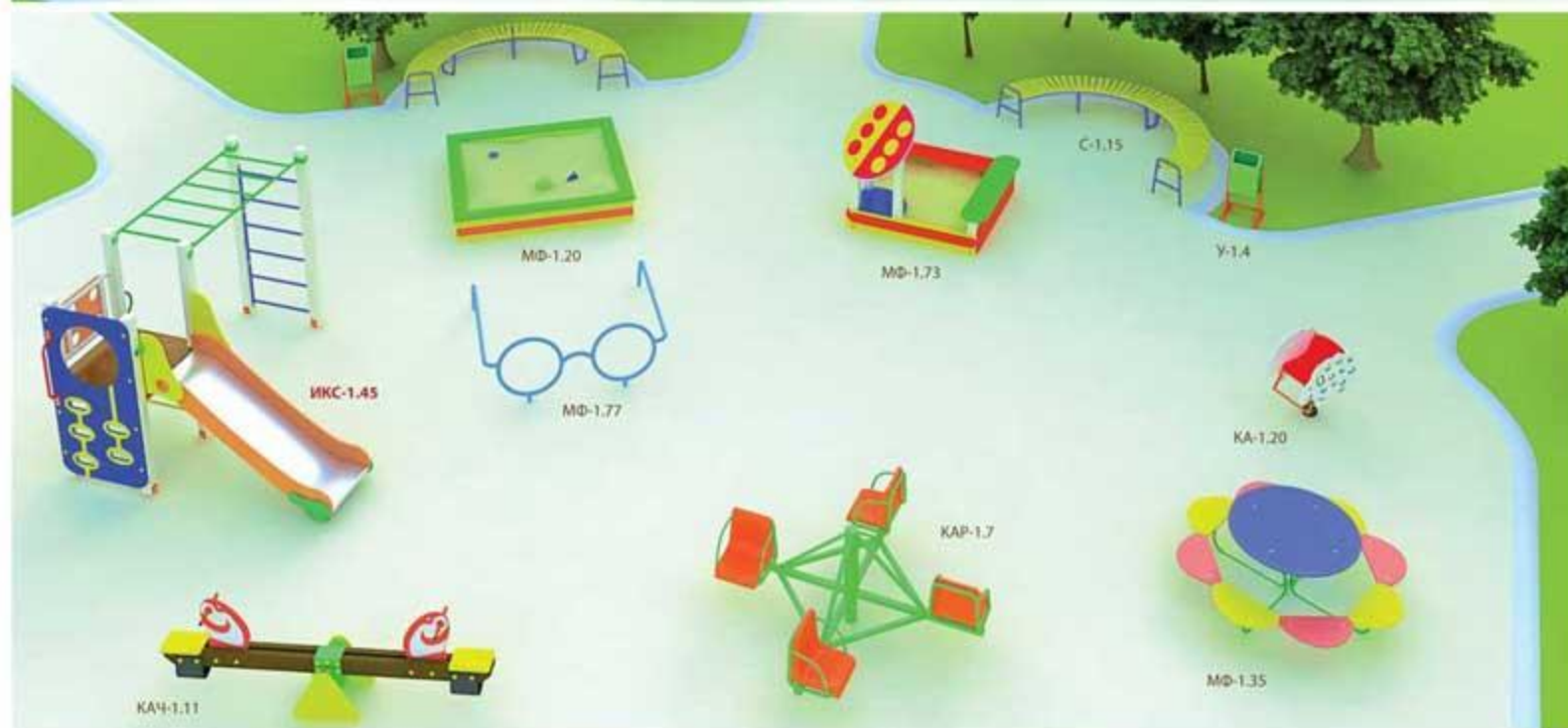

5+

ИКС-1.44



горка H=1450

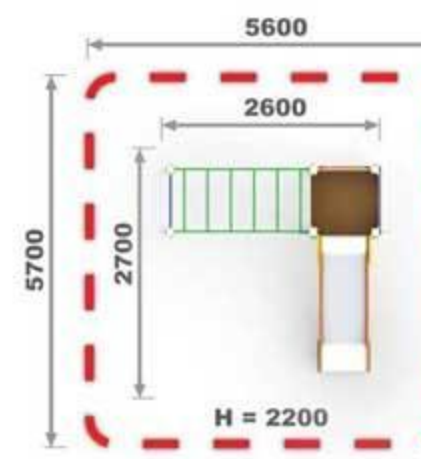

5+

ИКС-1.45



горка H=1000

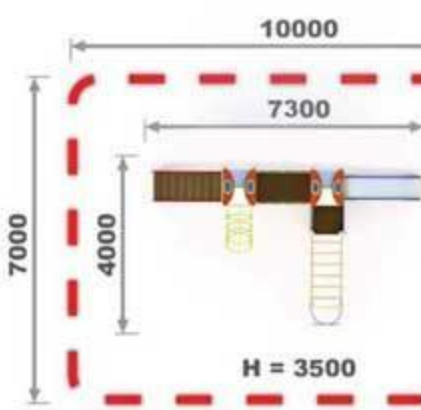

5+

ИКС-1.46



горка H=1450





ИКС-1.47

горка H=1000

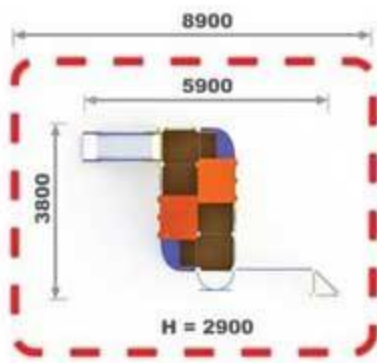

5+



ИКС-1.48

горка H=1000

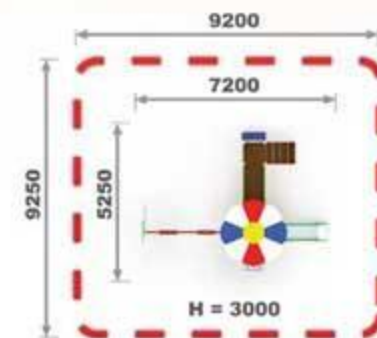

5+



ИКС-1.49

горка H=1450

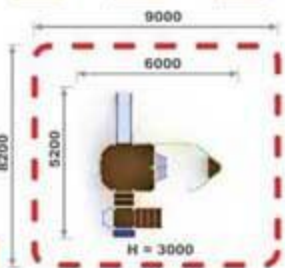

5+







ИКС-1.50



ИКС-1.51

ИКС-1.50



ИКС-1.52

Д-1.21

МФ-1.78

КАЧ-1.5

КА-1.7

КАЧ-1.6

ИКС-1.50

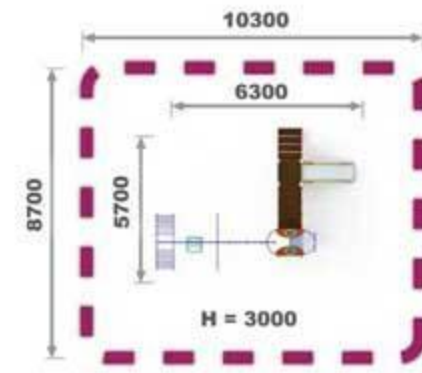

3+



горка H=1000

ИКС-1.51

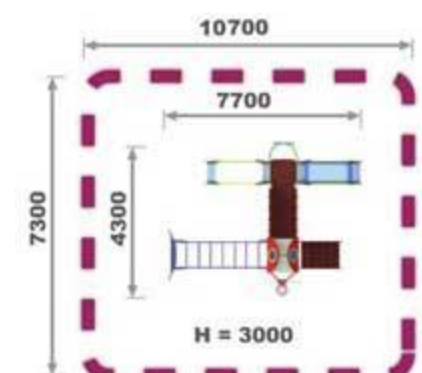

3+



горки H=1000

ИКС-1.52

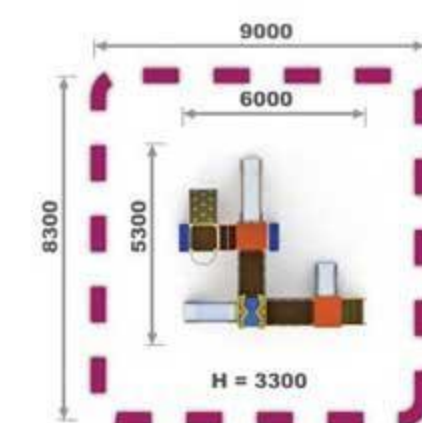

3+



горки H=500, H=1000, H=1450

ИКС ИГРОВЫЕ КОМПЛЕКСЫ



ИКС-БИО-1.0

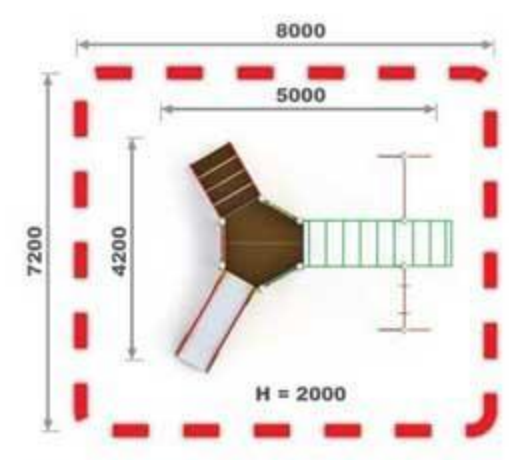

горка H=1000

ИКС-БИО-1.1

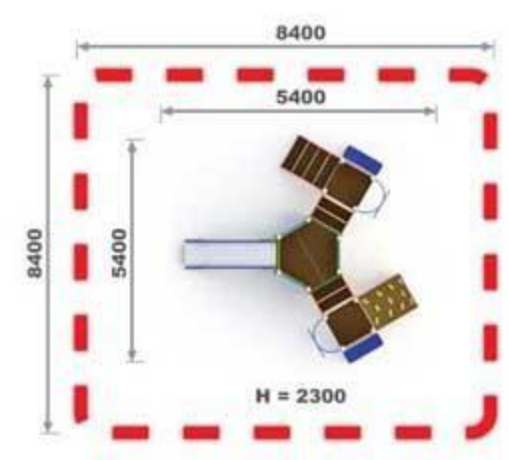

горка H=1450

ИКС-БИО-1.2

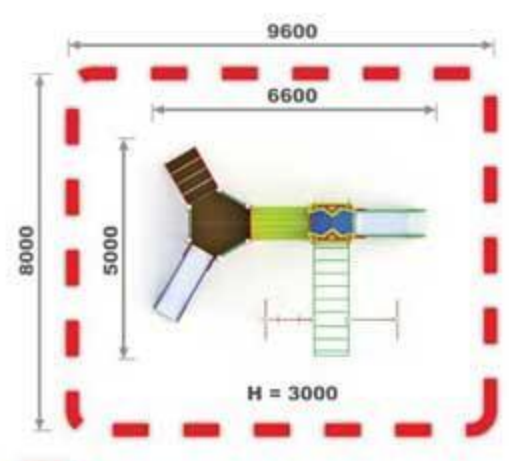

горки H=1000

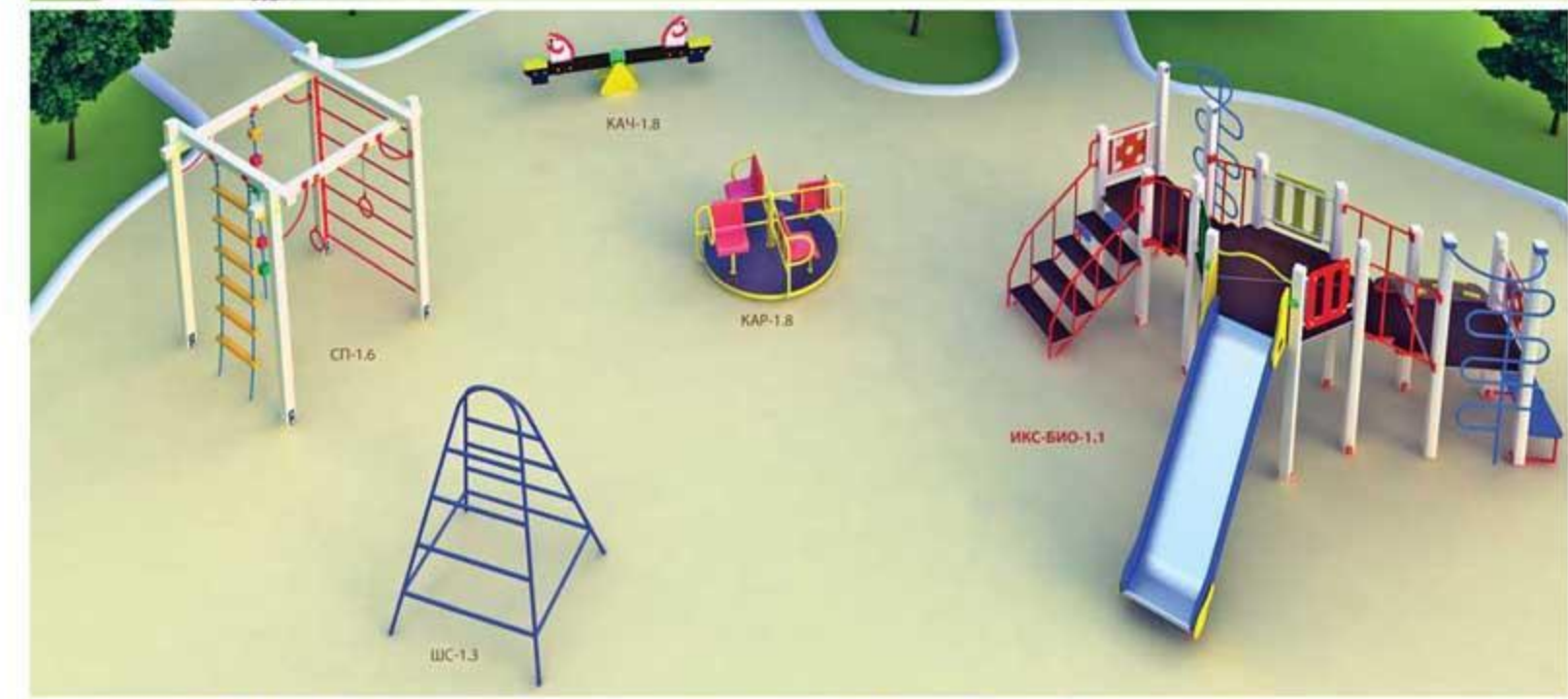





**ИКС-БИО-1.3**

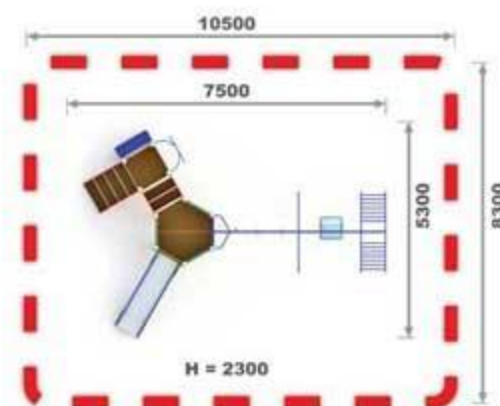

горка H=1450



3+

**ИКС-БИО-1.4**

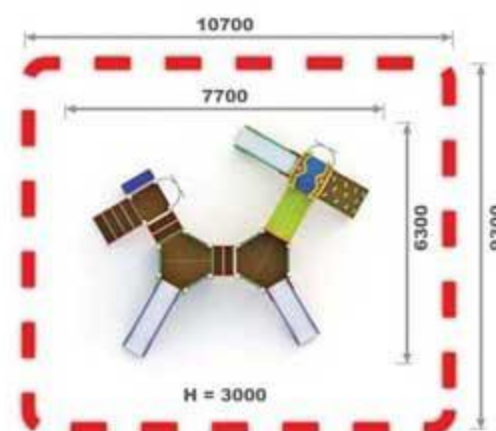

горки H=1000, H= 1450



3+

**ИКС-БИО-1.6**

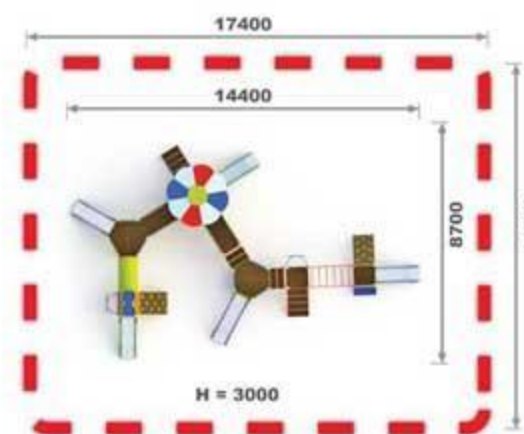

горки H=1000, H= 1450



3+



МГН-1.1



горка H=500  
заезд H=500

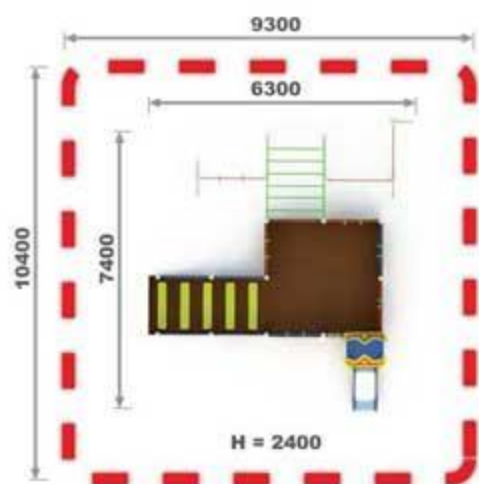

МГН-1.5



горка H=500  
заезд H=500

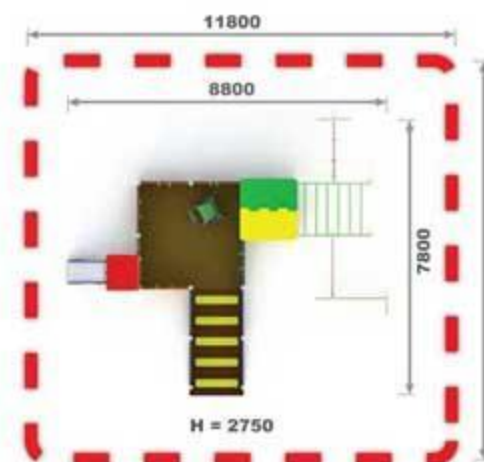

МГН-1.2



горка H=1000  
заезды H=500, H=1000

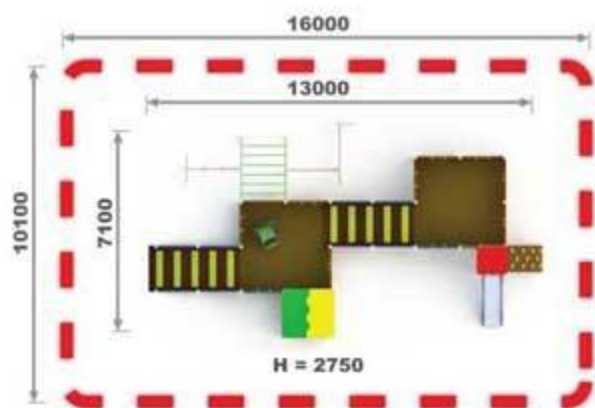

СПЕЦ-МФ-1.1



заезд H=500

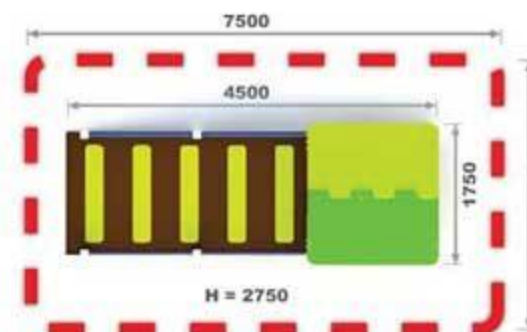

МГН-1.4



горка H=500  
заезд H=500

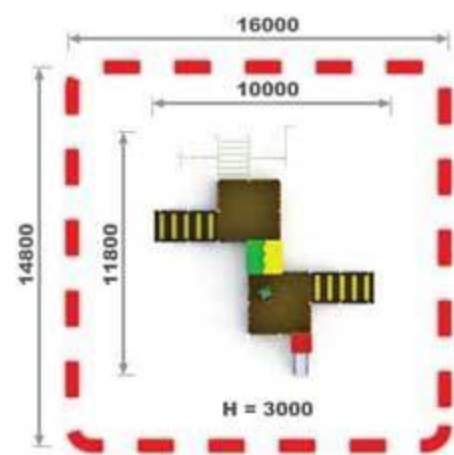

СПЕЦ-МФ-1.2

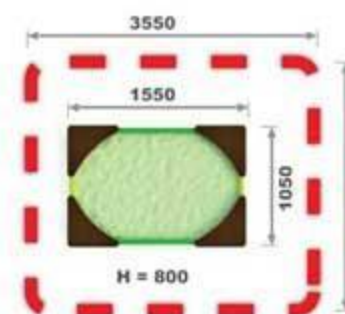

СПЕЦ-КАР-1.1

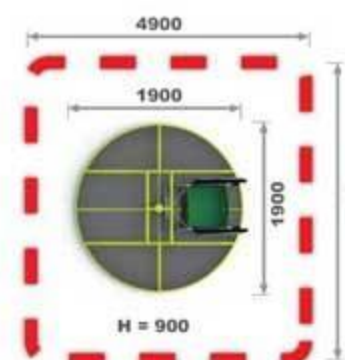



МФ-1.1.Ц



2+

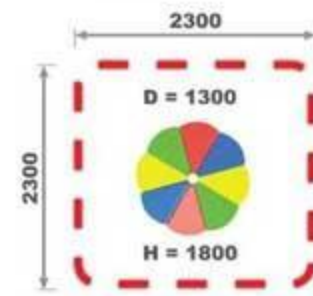

МФ-1.2



2+

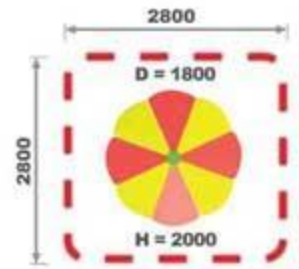

МФ-1.42



2+

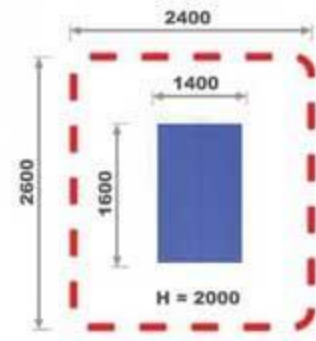

МФ-1.0



2+

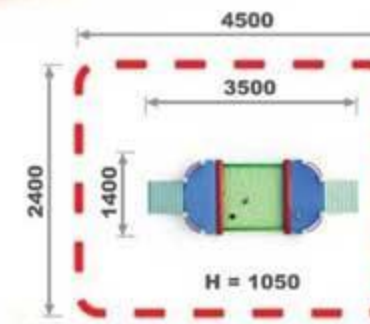

МФ-1.8



2+

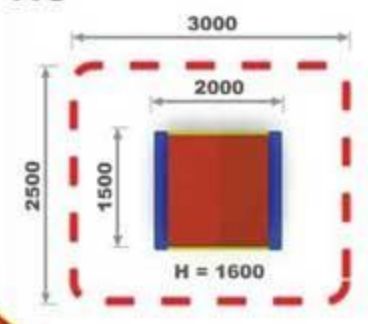

МФ-1.9



2+

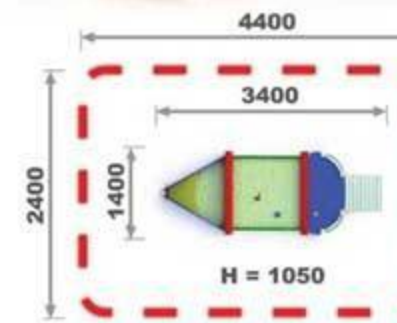

МФ-1.10



2+

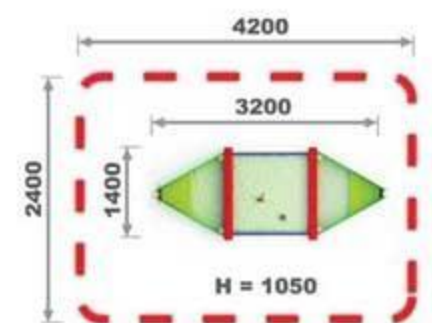

МФ-1.11



2+

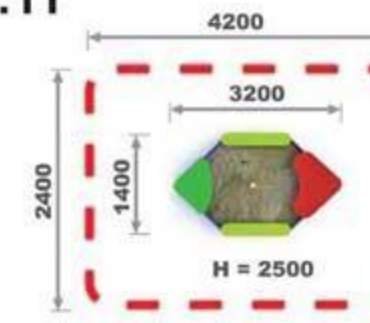

МФ-1.15



2+

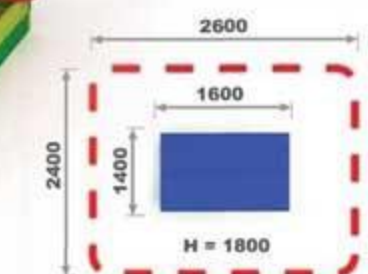



МФ-1.16



2+

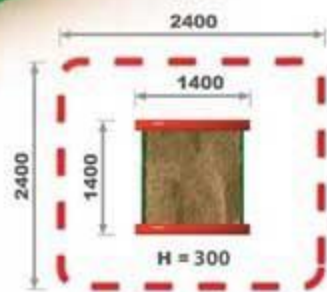

МФ-1.17



2+

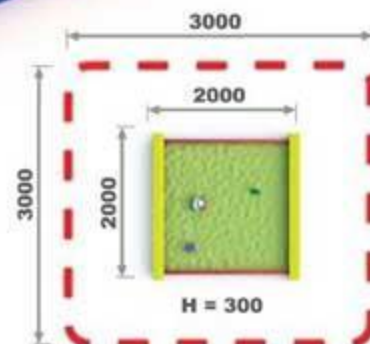

МФ-1.21



2+

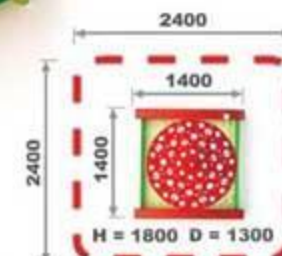

МФ-1.22



2+

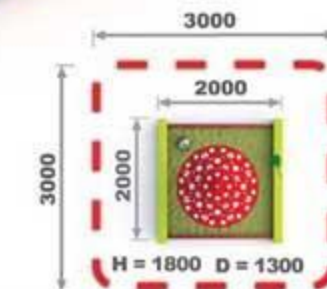

МФ-1.18

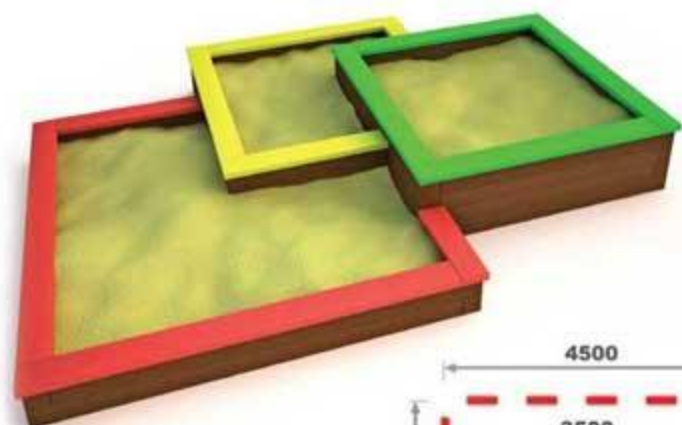

2+

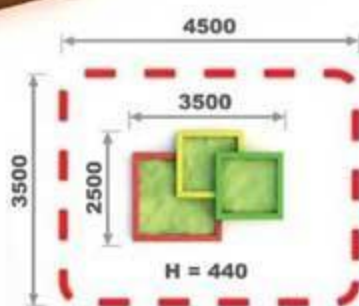

МФ-1.19.A

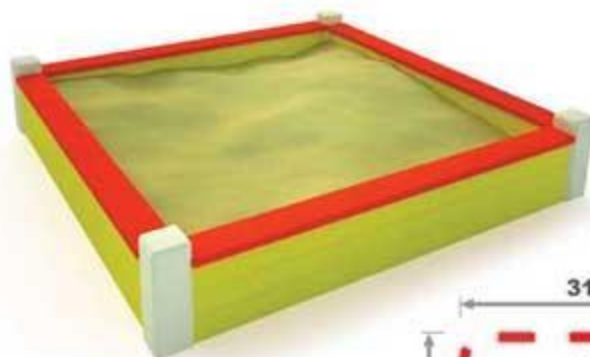

2+

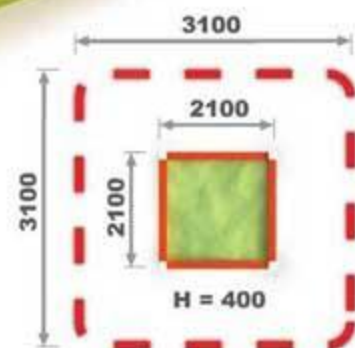

МФ-1.32

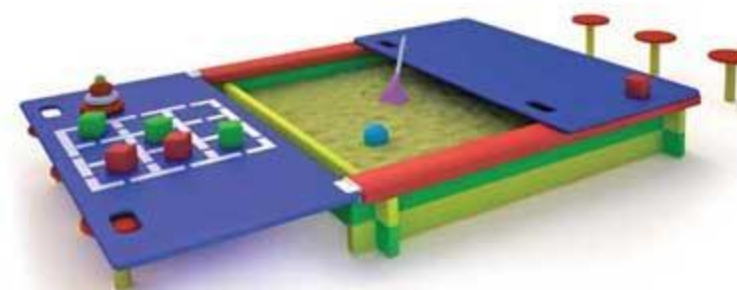

2+

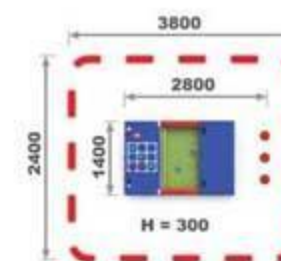

МФ-1.54

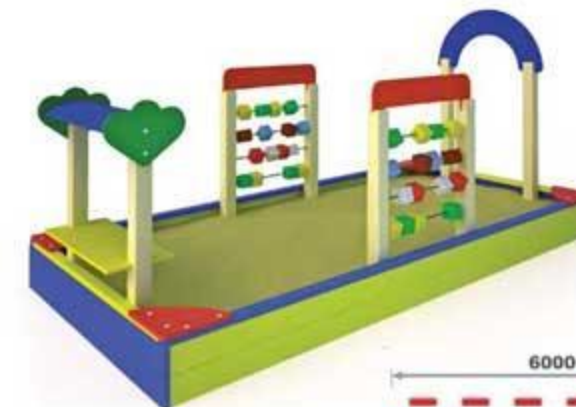

2+

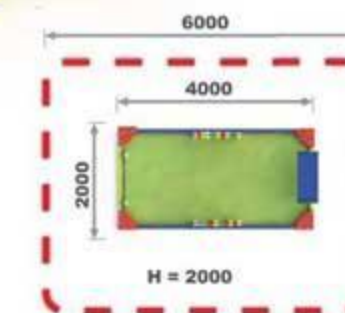

МФ-1.19.Б



2+

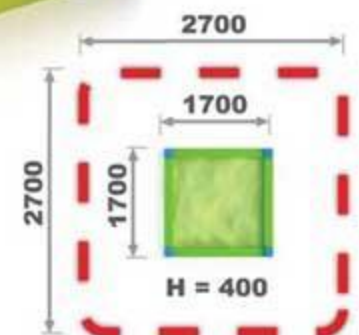

МФ-1.20



2+

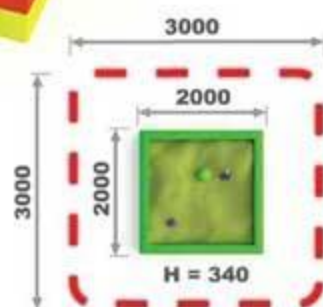

МФ-1.70



2+

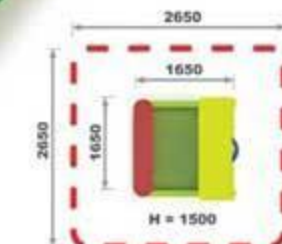

МФ-1.71



2+

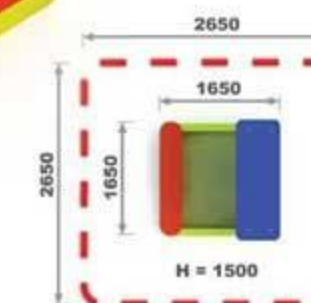



МФ-1.72

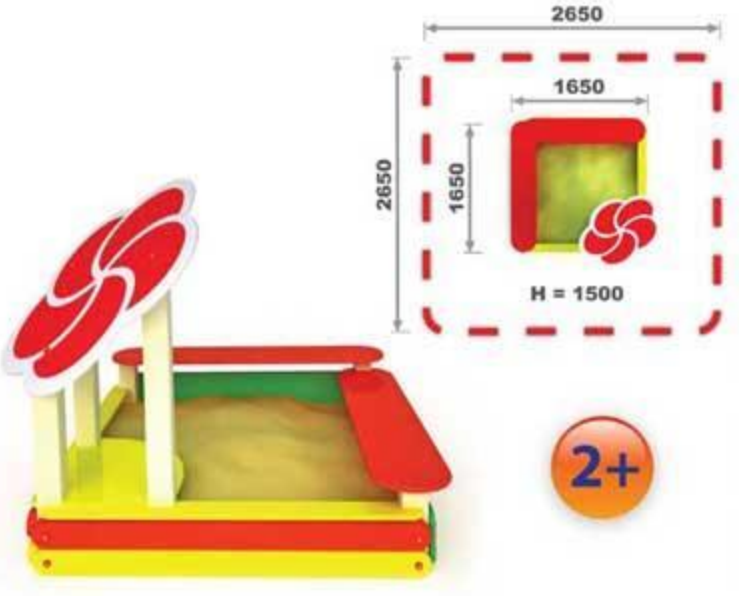

МФ-1.73

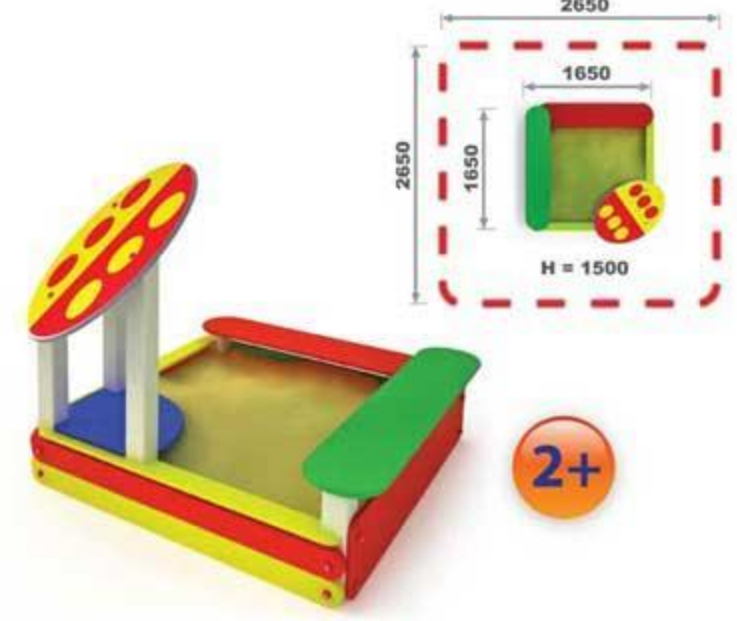

МФ-1.40



МФ-1.41

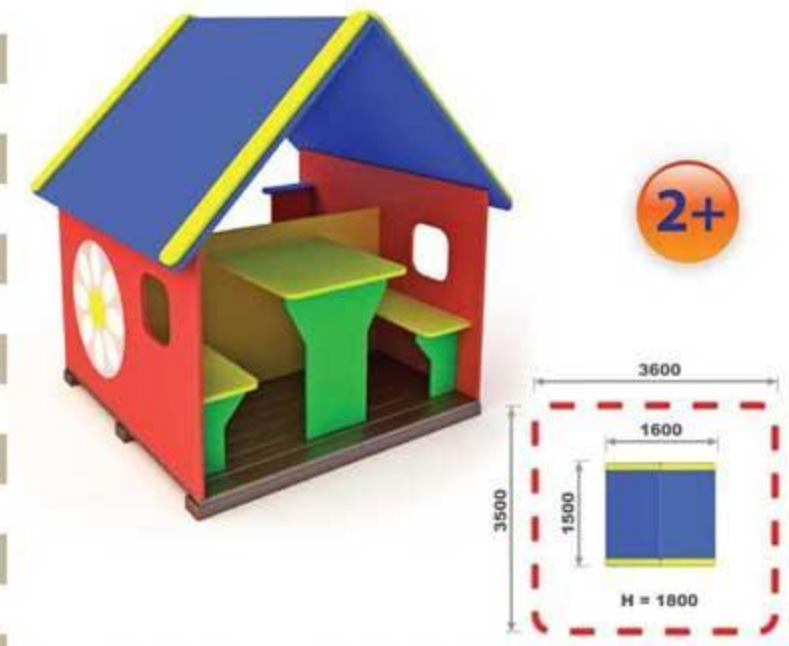

МФ-1.74



МФ-1.75



МФ-1.44



МФ-1.66

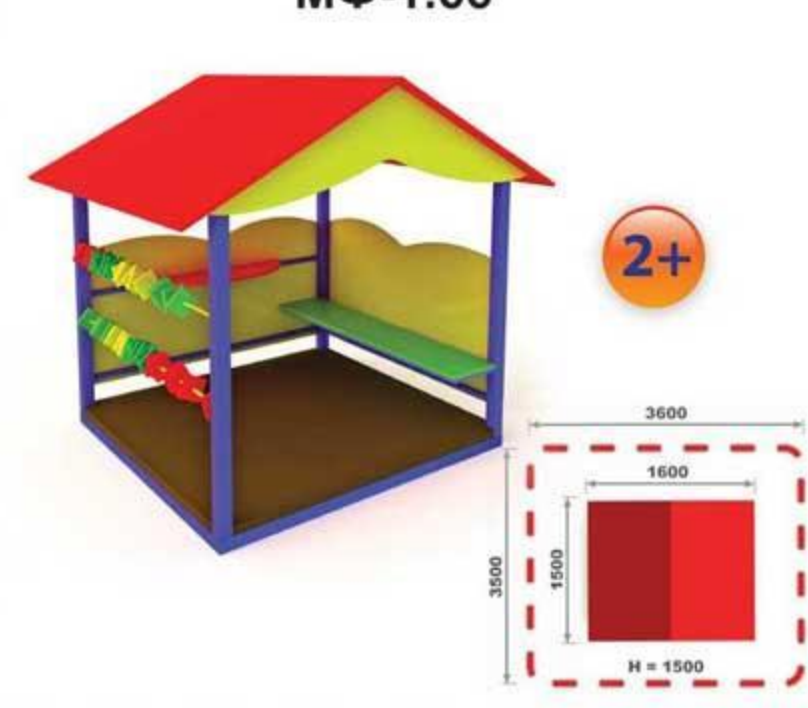

МФ-1.82



МФ-1.84

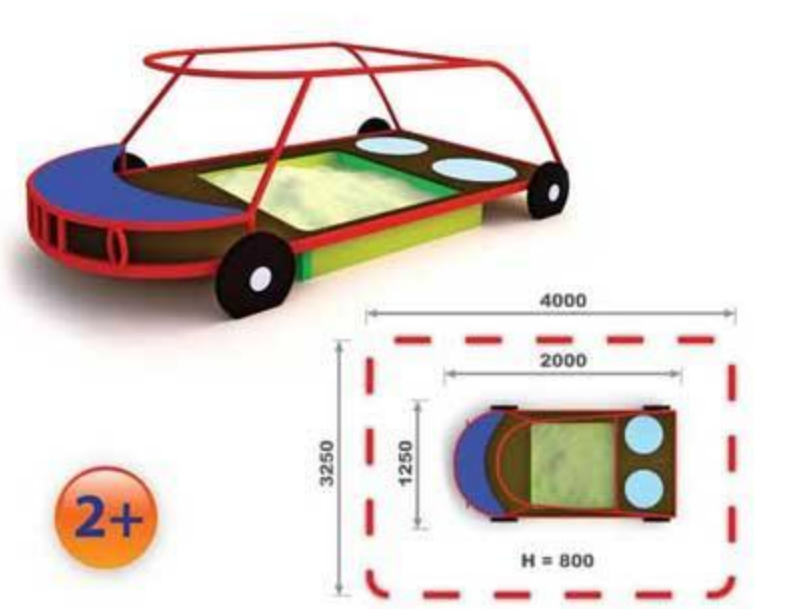

МФ-1.78



МФ-1.83

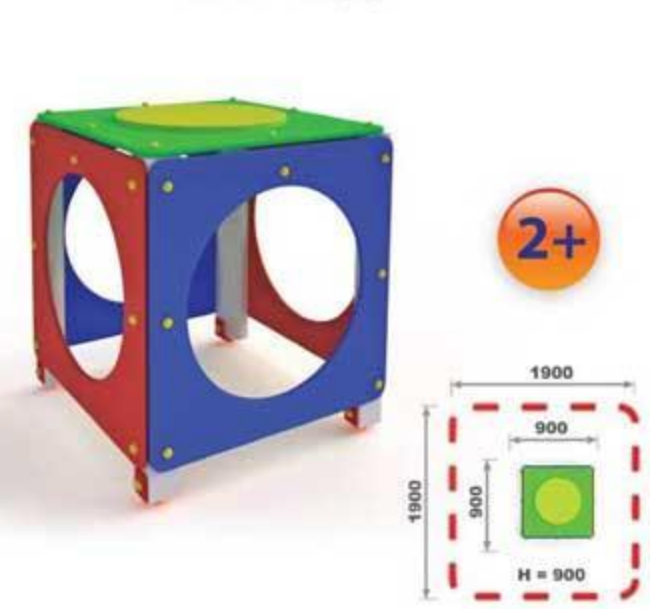



МФ-1.4 "Грузовик"



3+

горка H=500

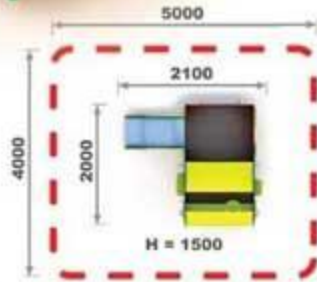

МФ-1.5 "Пожарная машина"



3+

горка H=500

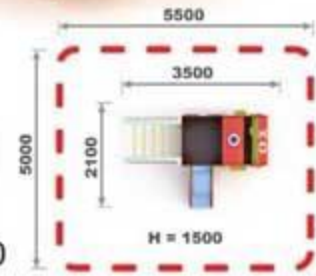

МФ-1.25 "Водомер"



3+

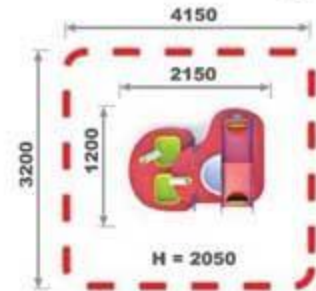

МФ-1.46 "Корабль"



3+

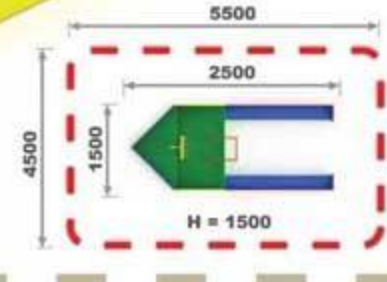

МФ-1.6 "Карета"



3+

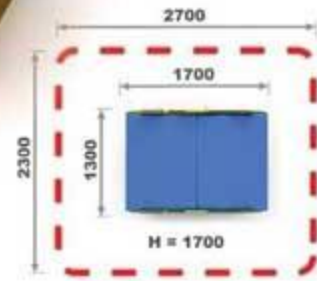

МФ-1.7 "Паровозик"



3+

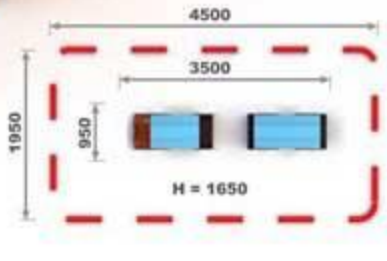

МФ-1.48 "Машинка"

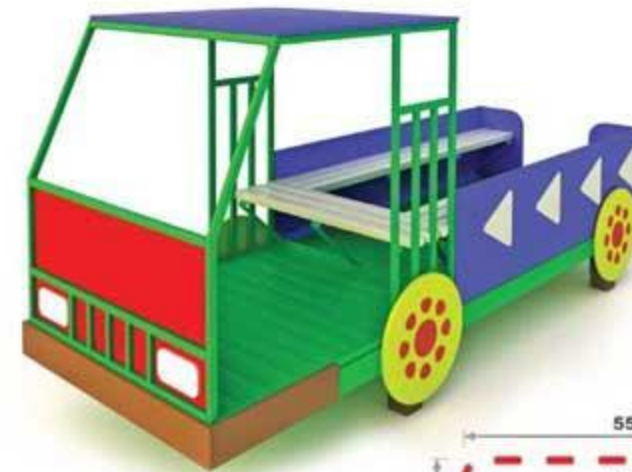

3+

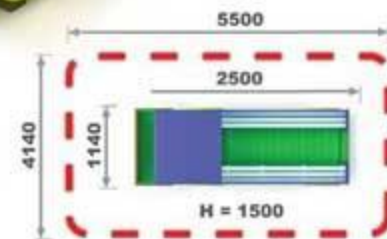

МФ-1.49 "Паровозик"

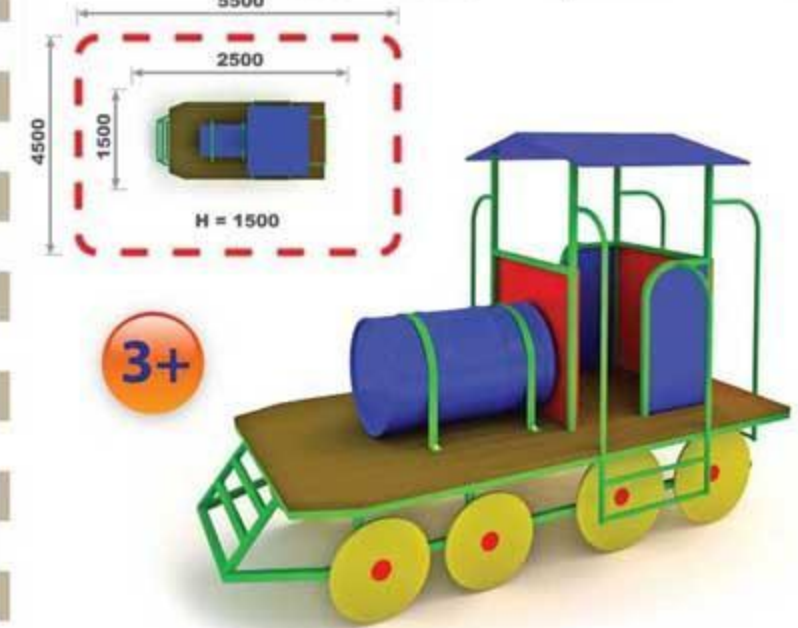

3+

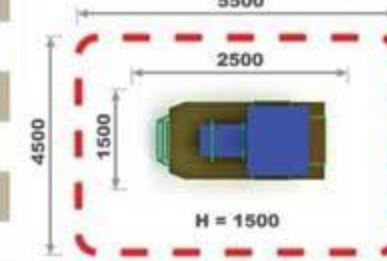

МФ-1.13 "Вертолет"



3+

горка H=1000

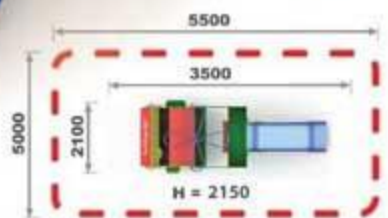

МФ-1.23 "Манеж"



1+

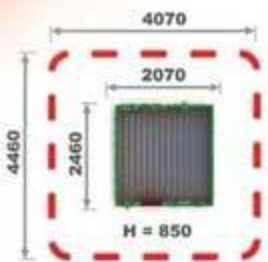

МФ-1.69 "Ту-ту"



3+

горка H=500

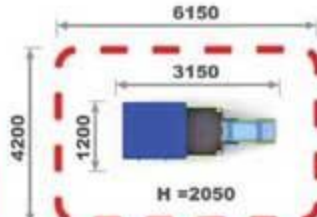

МФ-1.80 "Локомотив"

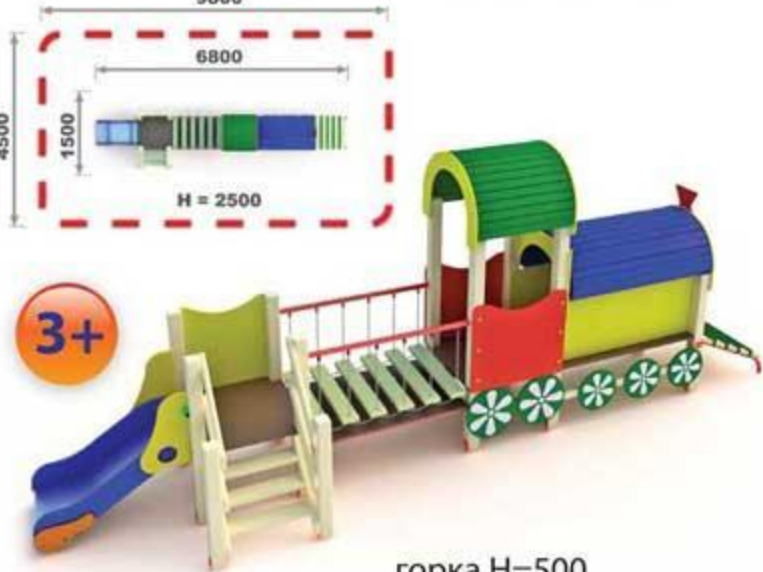

3+

горка H=500

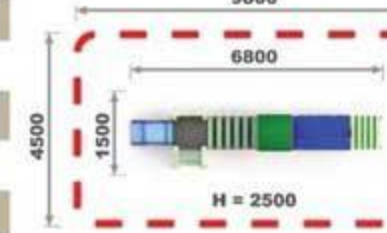



МФ-1.67 "Малыш"

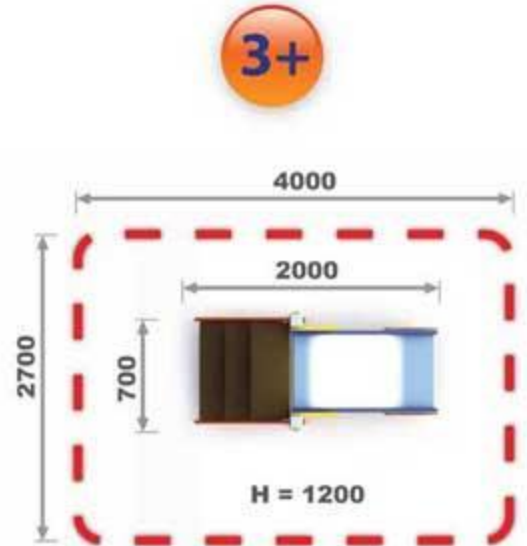

горка H=500

3+

МФ-1.24 "Паутинка"

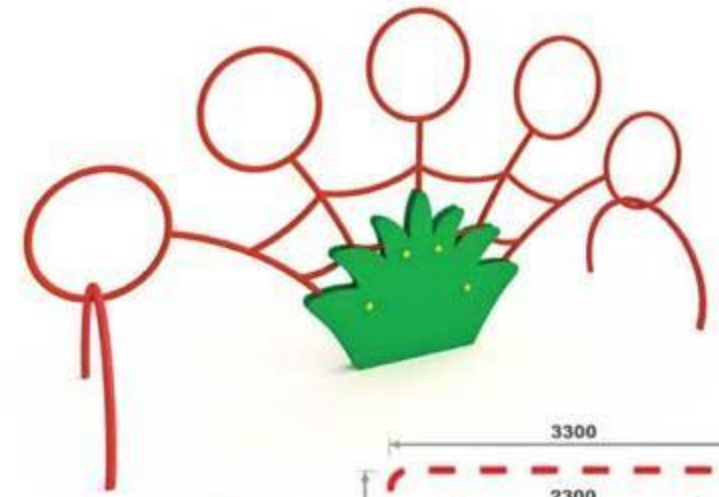

3+

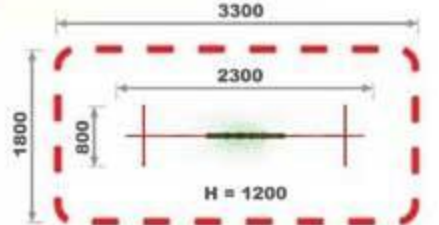

МФ-1.58 "Птичка"

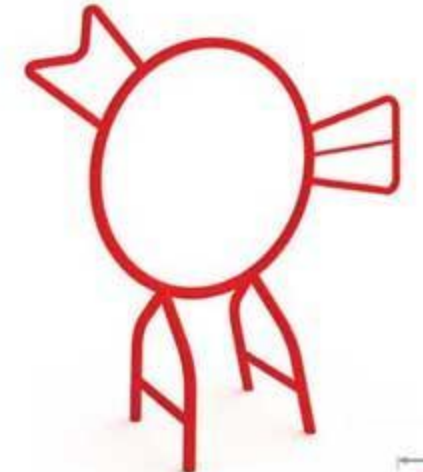

2+

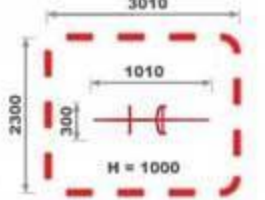

МФ-1.68 "Лайм"

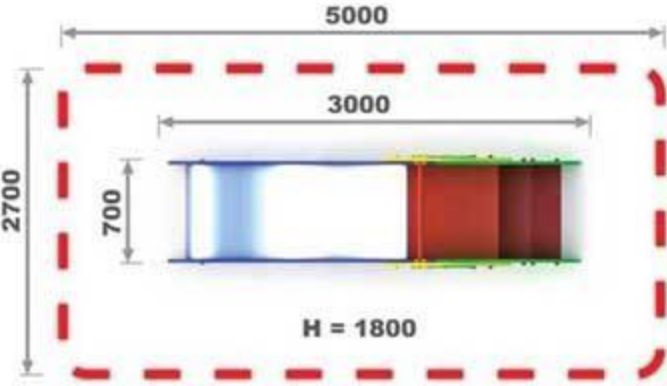

3+



горка H=1000

МФ-1.76 "Ракета"



2+

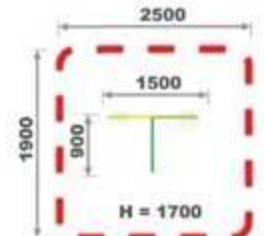

МФ-1.77 "Очки"

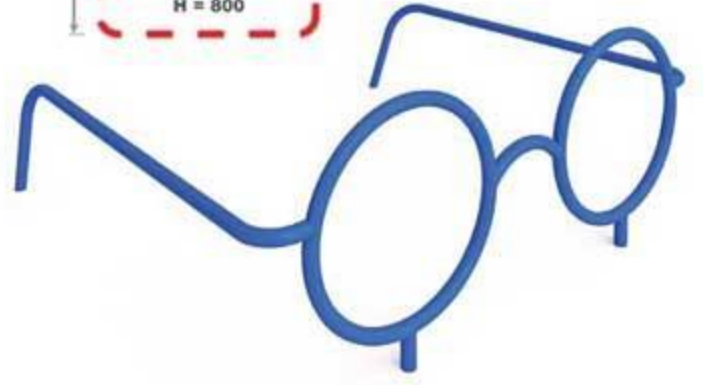

2+

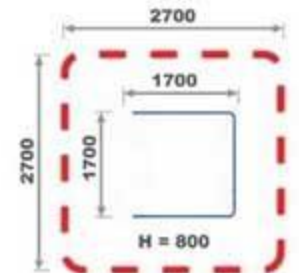

МФ-1.81 "Гусь"

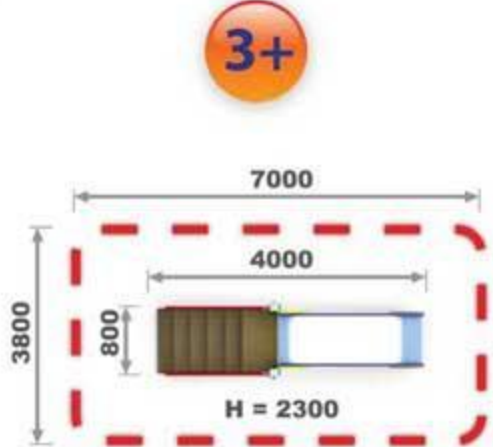

горка H=1450

3+



МФ-1.81

МФ-1.24

МФ-1.76



МФ-1.33 "Овальный"



2+

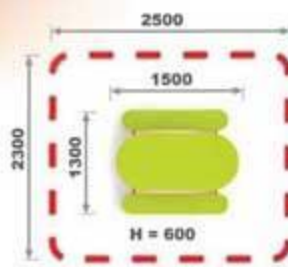

МФ-1.34 "Семицветик"



2+

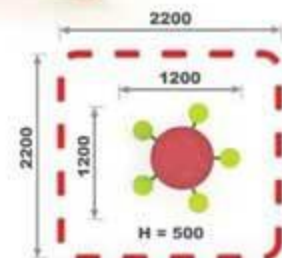

МФ-1.51А "Столик песочный"

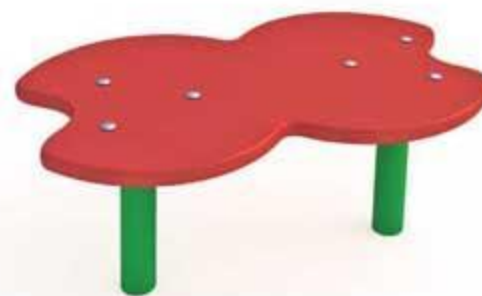

2+

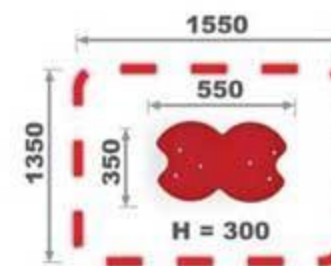

МФ-1.52 "Столик песочный"



2+

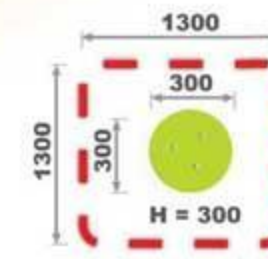

МФ-1.35 "Лучистый"



2+

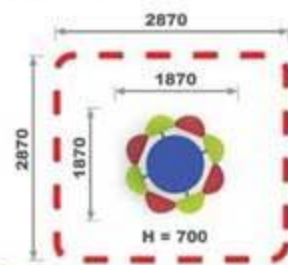

МФ-1.38 "Солнышко"



2+

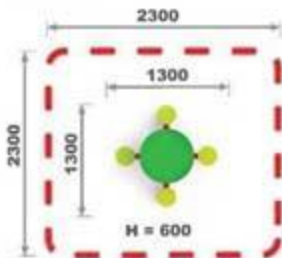

МФ-1.52А "Столик песочный"



2+

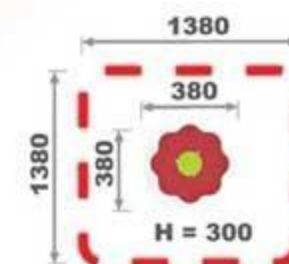

МФ-1.29 "Гусеница"



2+

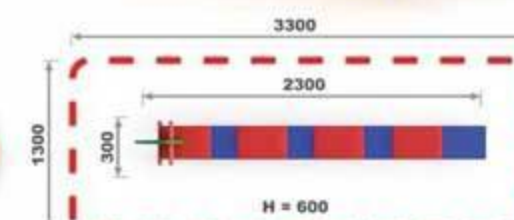

МФ-1.39 "Под грибом"

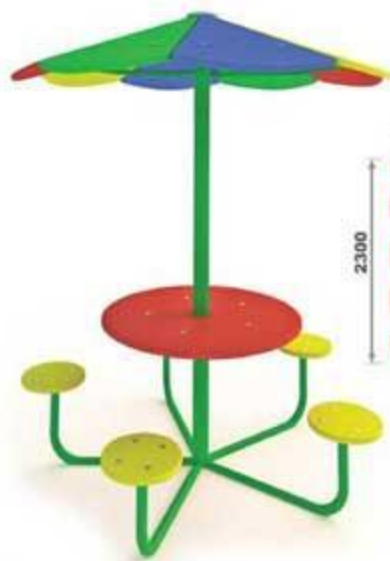

2+

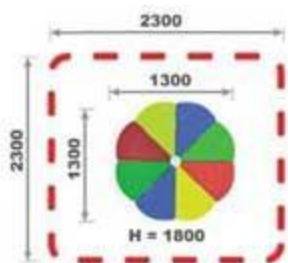

МФ-1.51 "Столик песочный"



2+

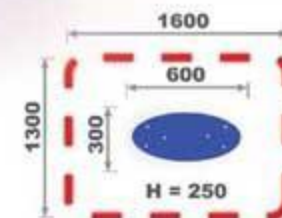

МФ-1.30 "Гусеница"(брус)

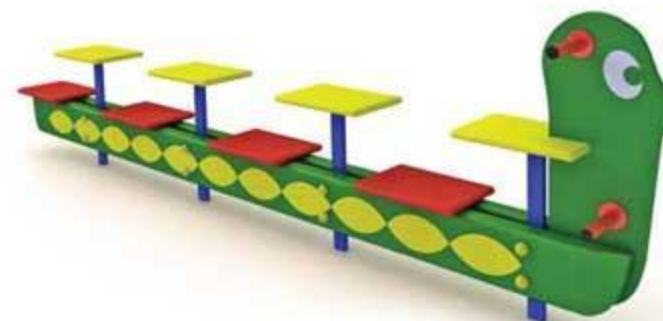

2+

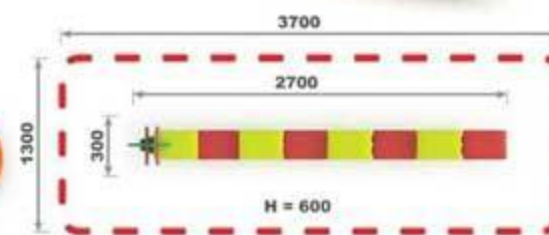

МФ-1.53 "Ступени"



2+

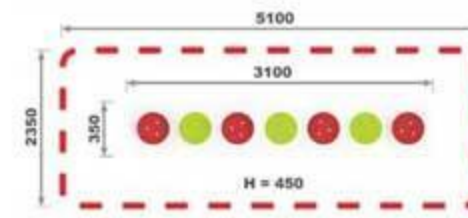



СД-1.1 "Слоник"

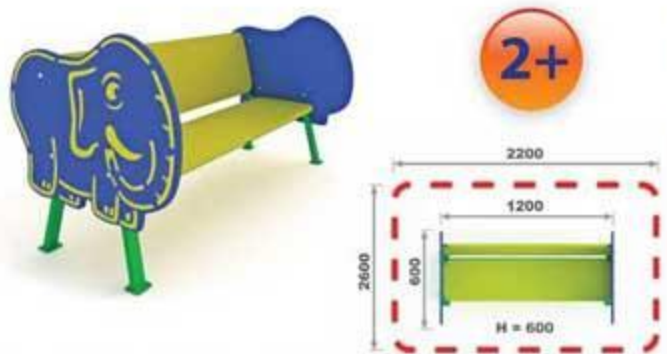

СД-1.2 "Зебра"

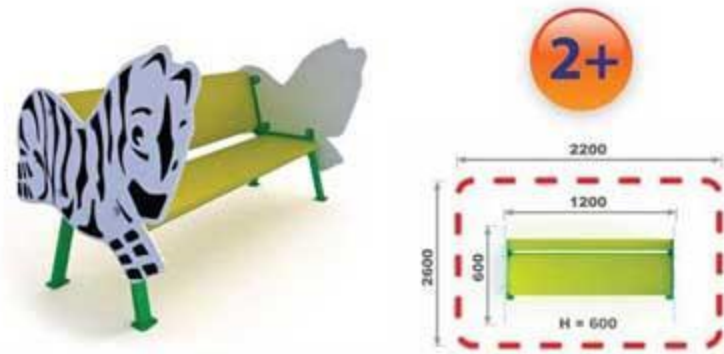

КА-1.3 "Z"

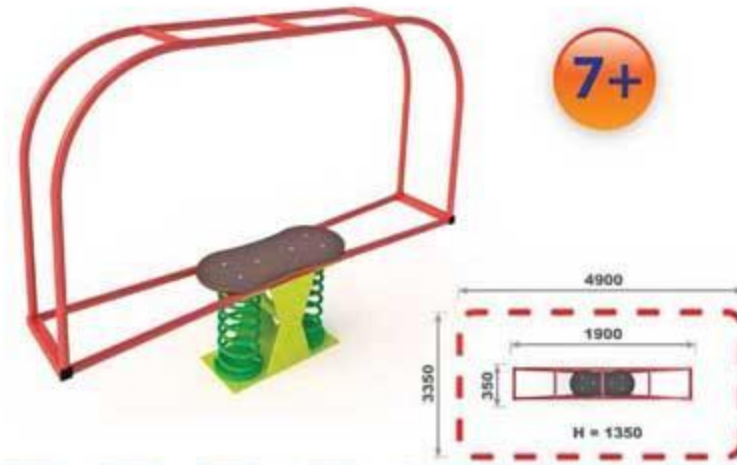

КА-1.6

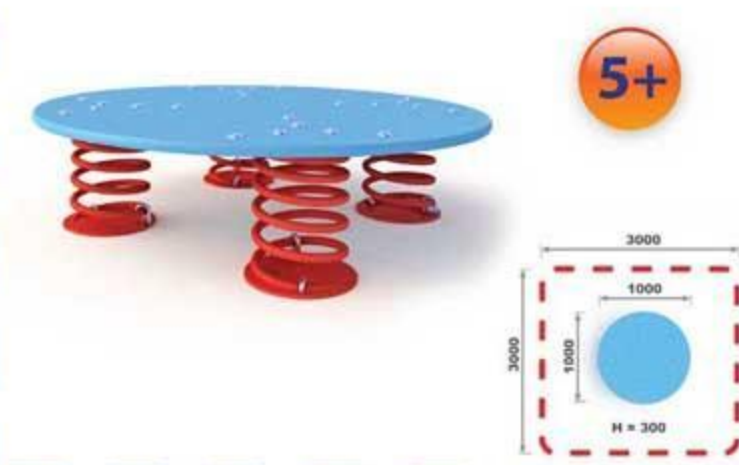

СД-1.3 "Овечка"

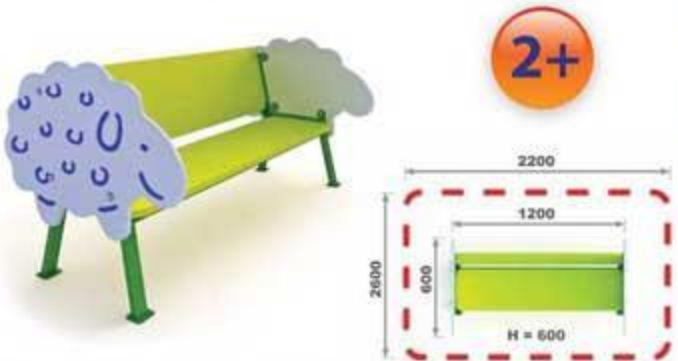

СД-1.4 "Весельчак"

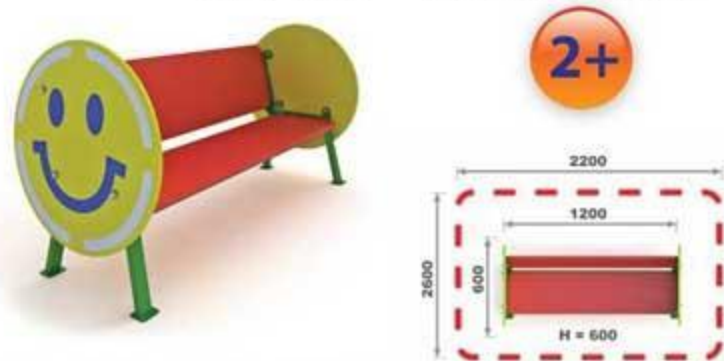

КА-1.7



КА-1.8

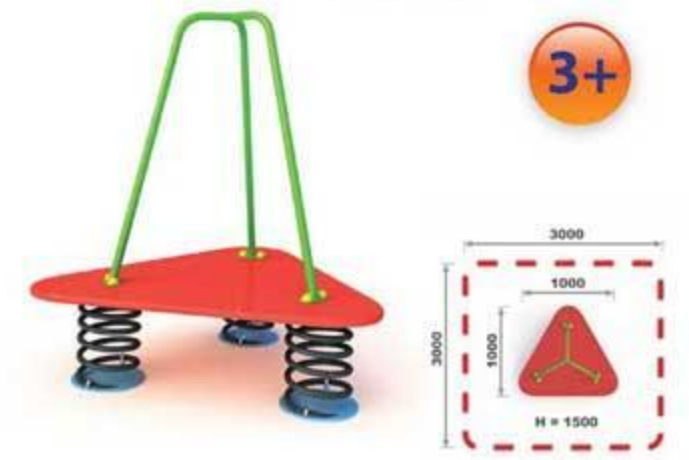

СД-1.5 "Звёздочка"

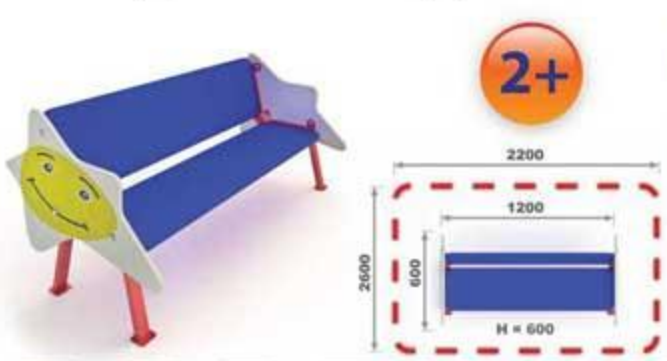

СД-1.6 Треугольник

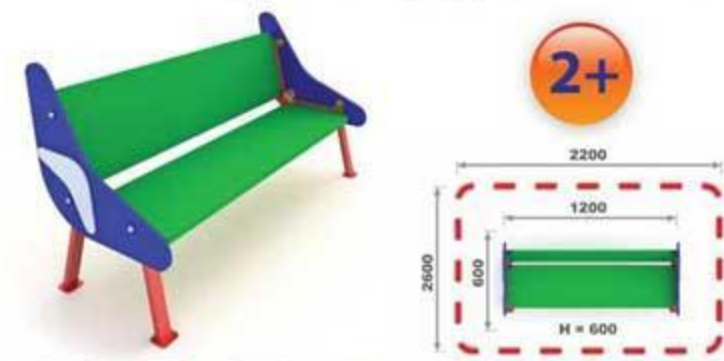

КА-1.11 "Лошадка"

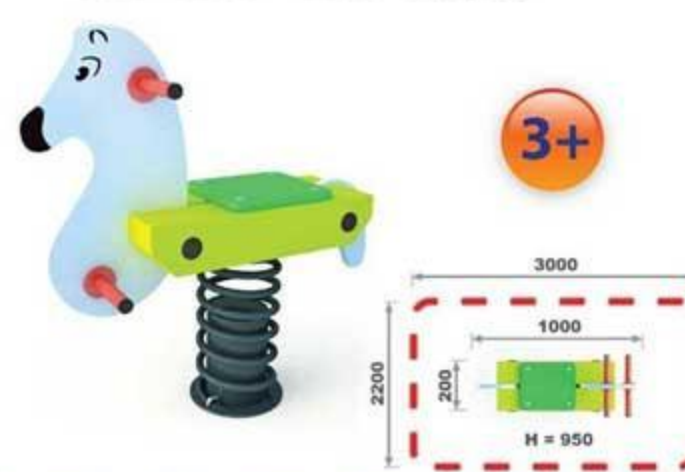

КА-1.12 "Собачка"

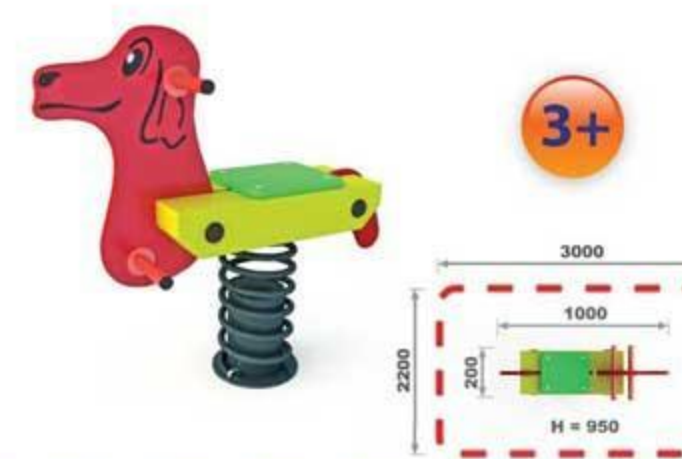

СД-1.7 "Кубик"

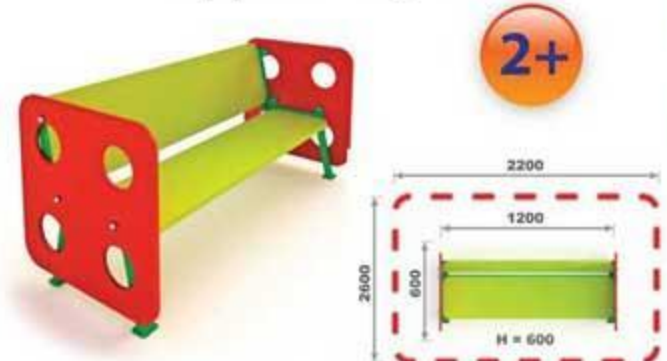

СД-1.8 "Овал"



КА-1.13 "Утёнок"



КА-1.14 "Зебра"



СД-1.9 "Кит"

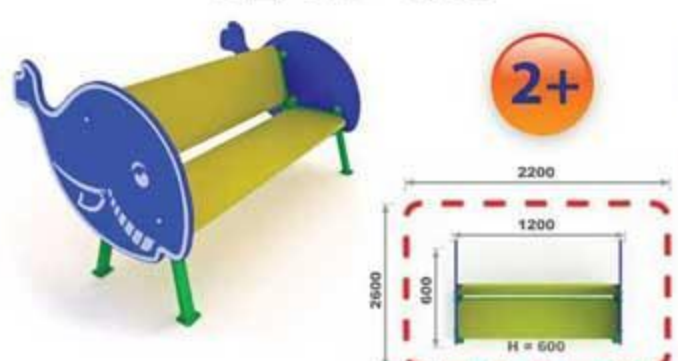

СД-1.10 "Дельфин"

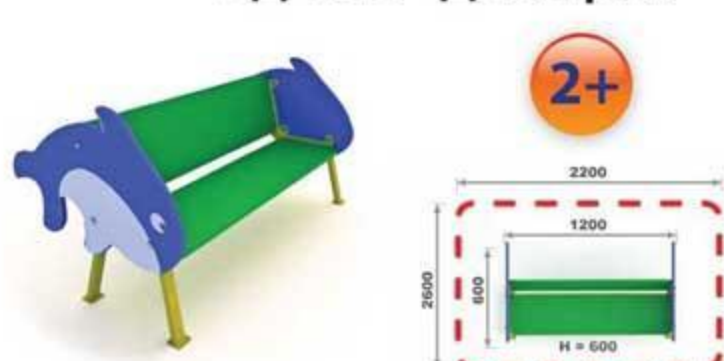



КА-1.15 "Китёнок"

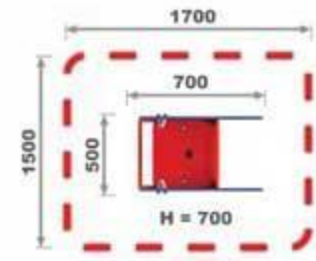

3+

КА-1.16 "Зебра"

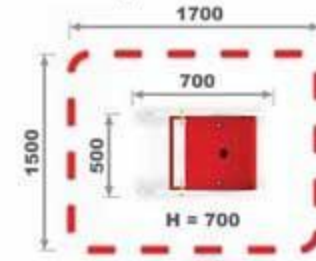

3+

КАЧ-1.2 "Чижик"

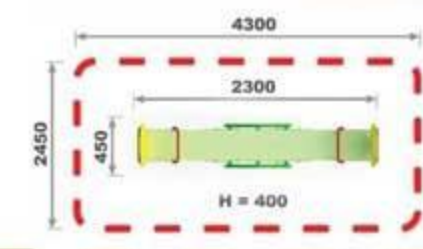

2+

КАЧ-1.6 "Лошадка"

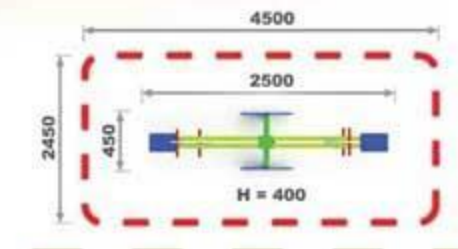

2+

КА-1.17 "Крокодил"

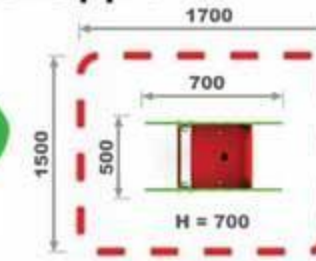

3+

КА-1.18 "Слонёнок"

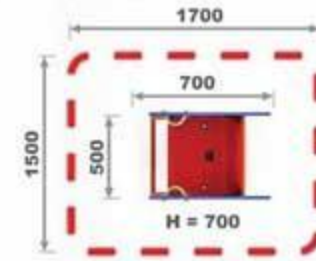

3+

КАЧ-1.7 "Лошадки"

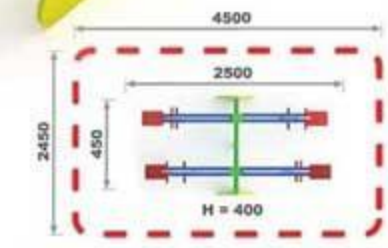

2+

КАЧ-1.10 "Акула"

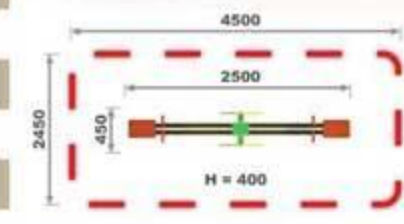

2+

КА-1.19 "Астронавт"

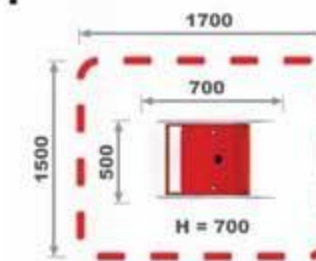

3+

КА-1.20 "Овечка"

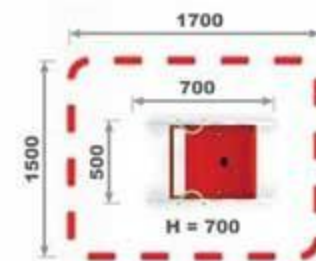

3+

КАЧ-1.11 "Краб"

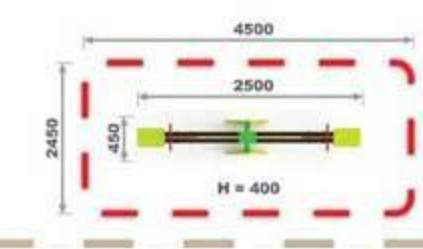

2+

КА-1.21 "Рыбка"

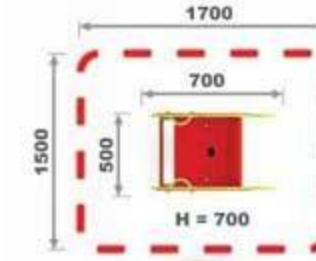

3+

КА-1.22 "Звездочка"

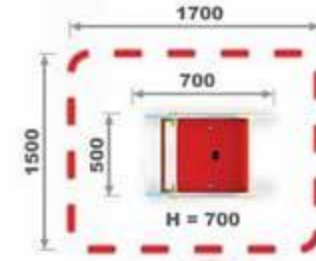

3+

КАЧ-1.14 "Шарпей"

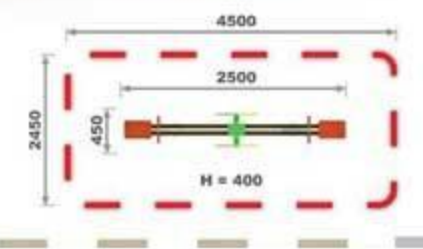

2+

КА-1.23 "Джип"

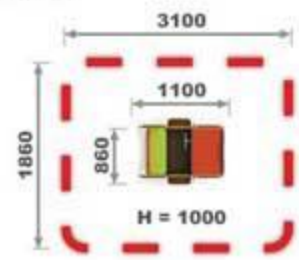

3+

КА-1.24 "Месяц"

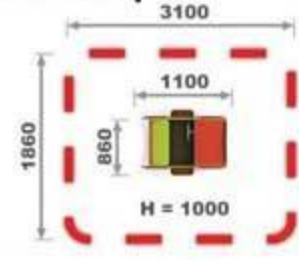

3+



КАЧ-1.3

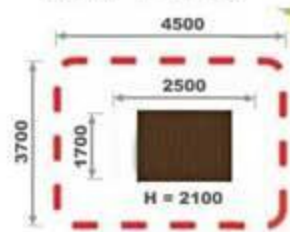

3+

КАЧ-1.5

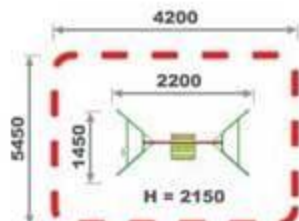

3+

КАР-1.1

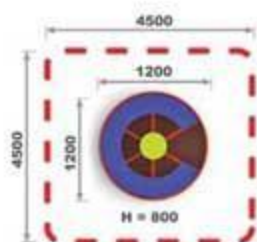

3+

КАР-1.3

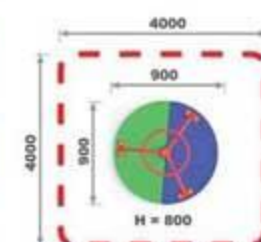

3+

КАЧ-1.8

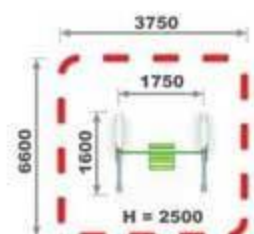

3+

КАЧ-1.9

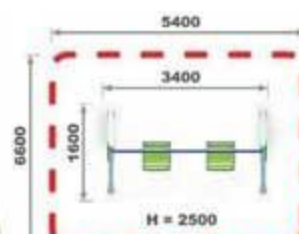

3+

КАР-1.6 "Летающие ноги"

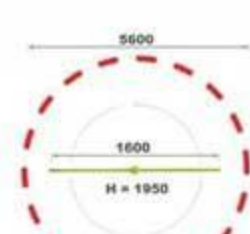

5+

КАР-1.6А "Летающие ноги-2"

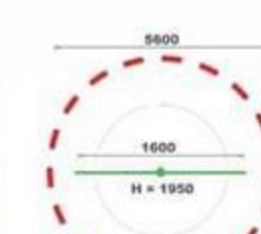

5+

КАЧ-1.12

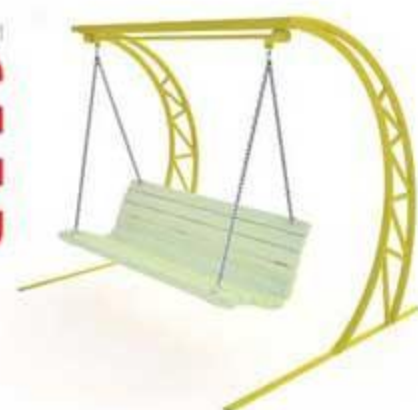
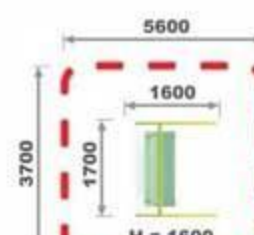

3+

КАЧ-1.12А

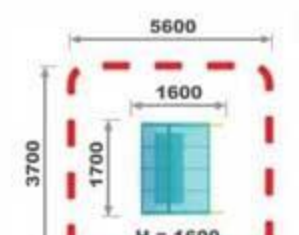

3+

КАР-1.7 "Шапито"

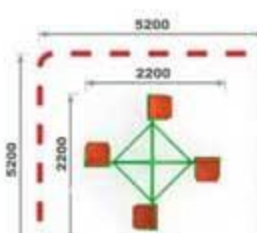

5+

КАР-1.8 "Морская"

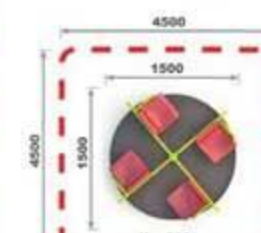

5+

КАЧ-1.13 "Полет"

3+

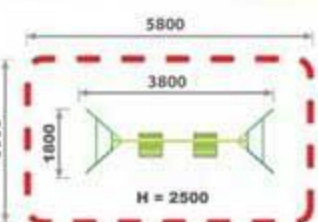

КАР-1.10

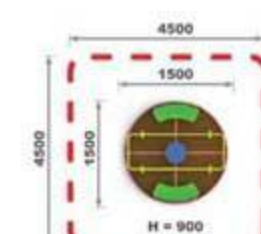

5+



ББ-1.1

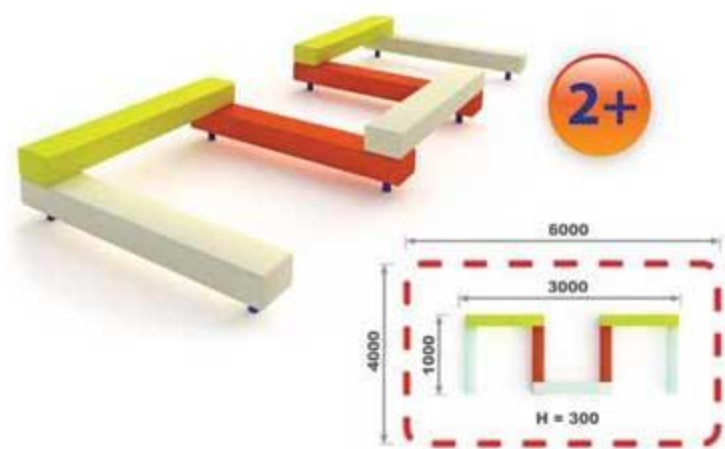

2+

ББ-1.2

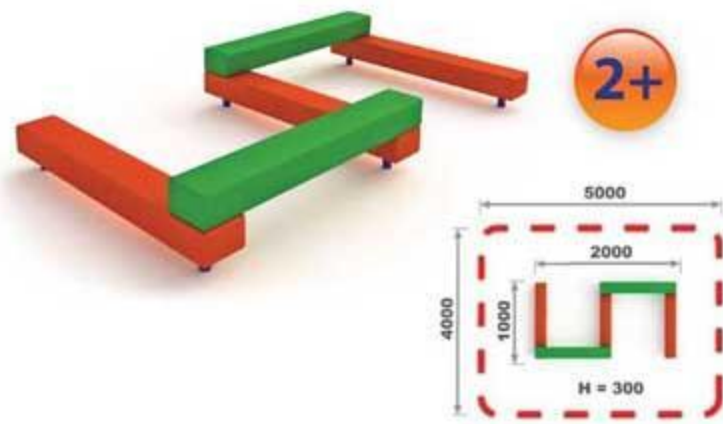

2+

ЛАБ-1.1

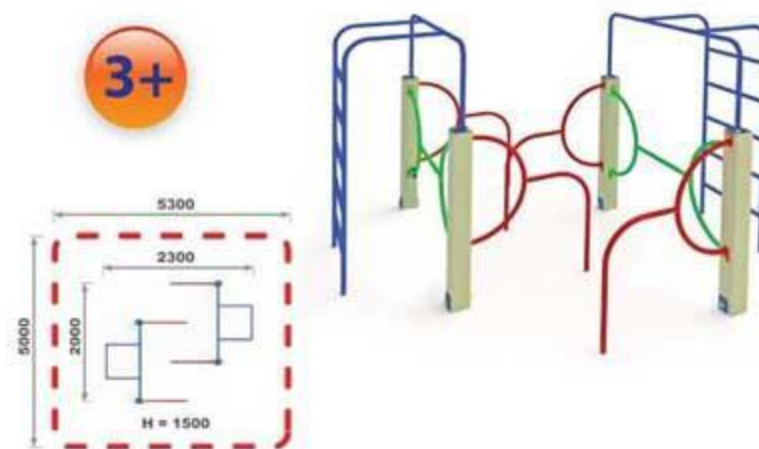

3+

ЛАБ-1.2



3+

ББ-1.3



7+

ББ-1.4

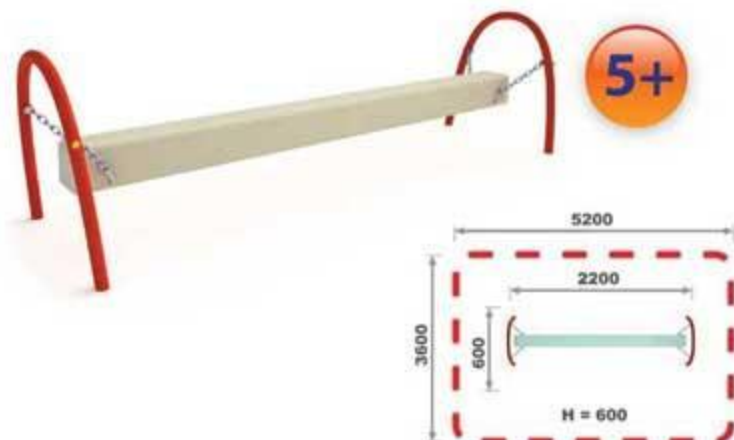

5+

РУ-1.1 "Лесенка"



7+

РУ-1.2 "Карибы"

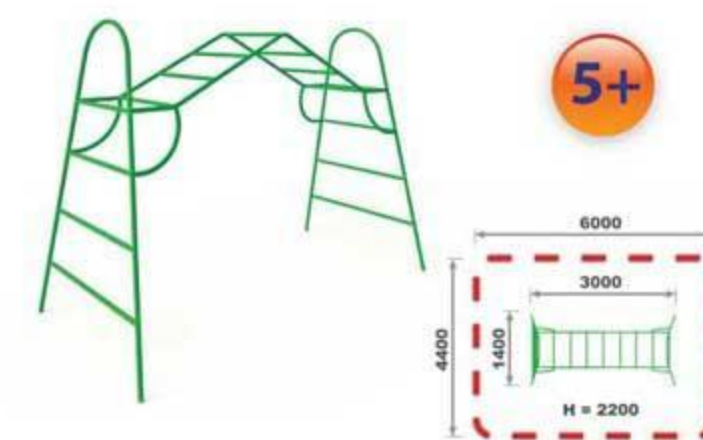

5+

ББ-1.5



5+

РУ-1.3 "Карибы" (брус)

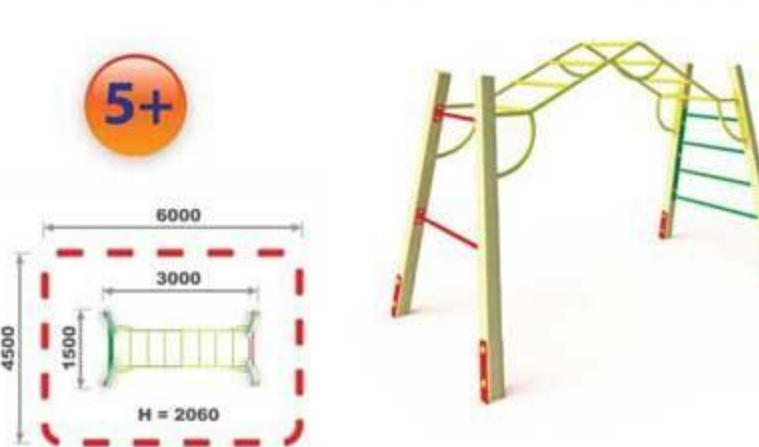

5+

РУ-1.4 "Пирамида"



7+

ББ-1.8

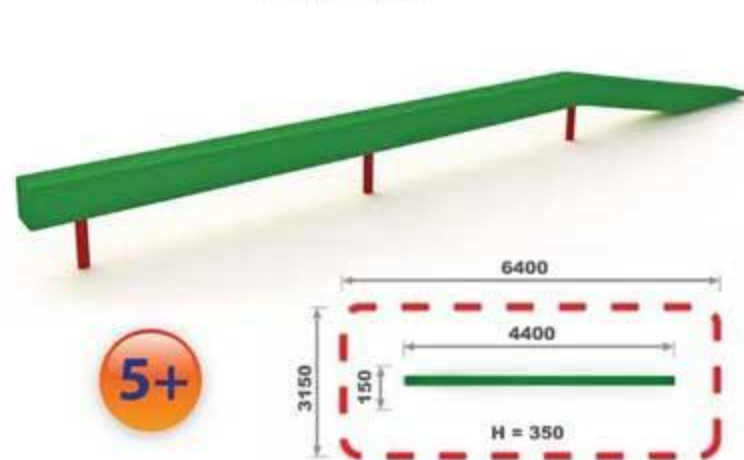

5+

ББ-1.9

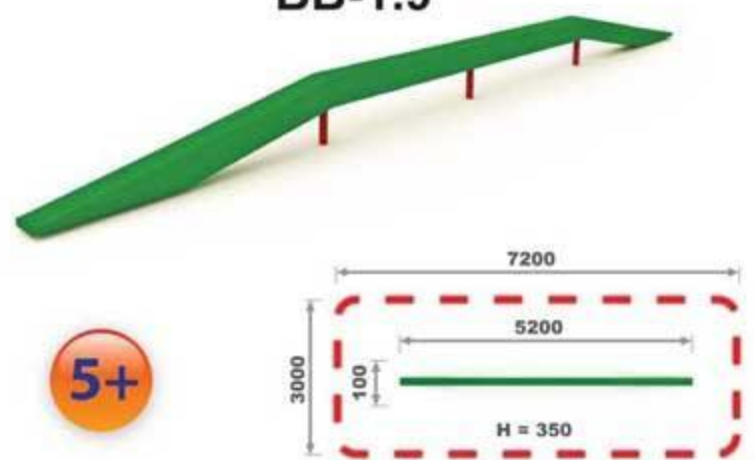

5+

РУ-1.6 "Плюс"

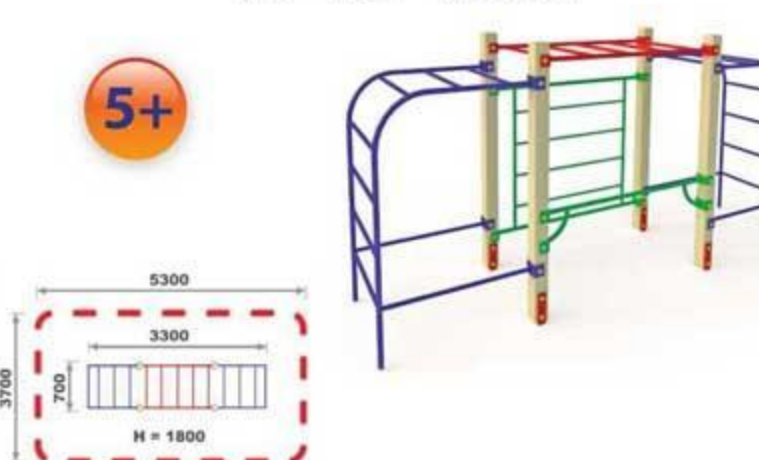

5+

РУ-1.7

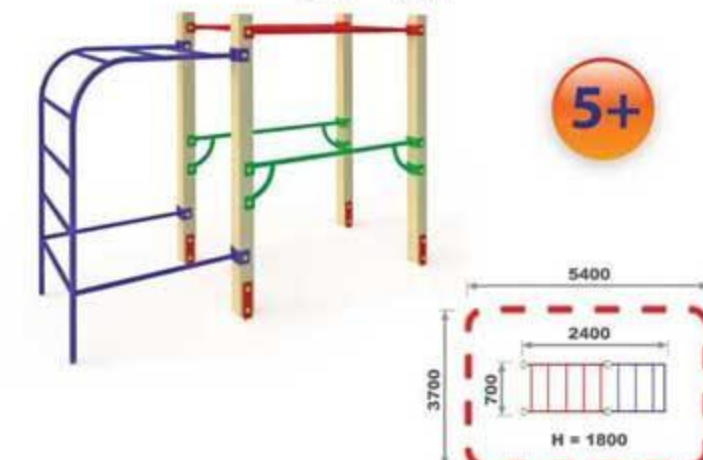

5+



ШС-1.1 "Завиток"

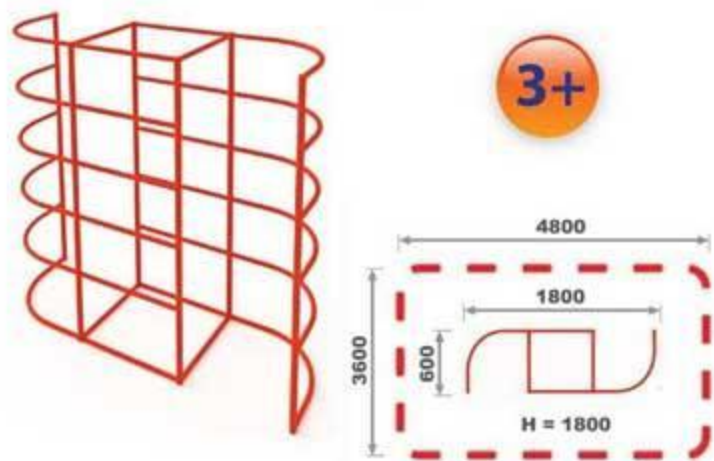

ШС-1.3 "Стремянка"

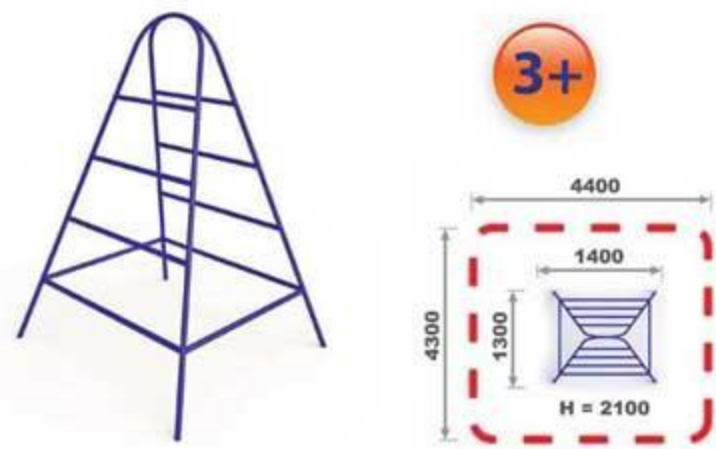

лесенка СП-1.59



СП-1.70 "Школьник"



ШС-1.2 "Завиток-1"

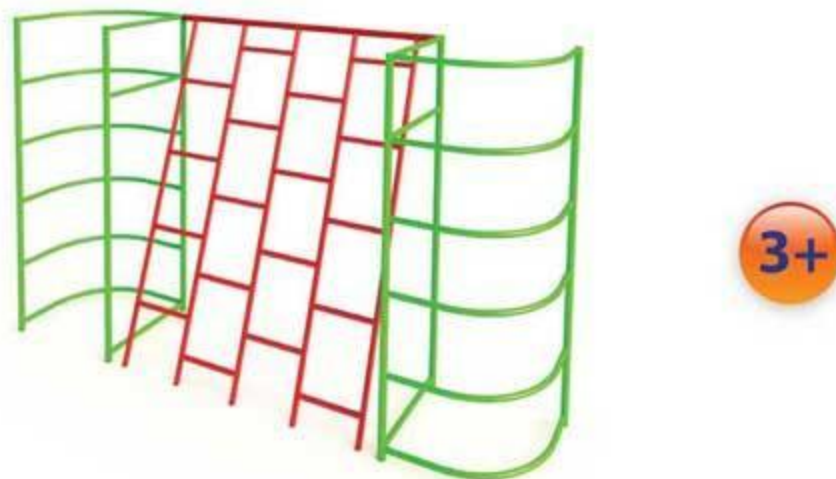
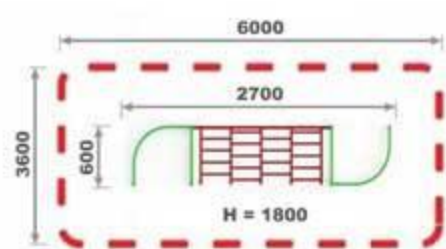

барьер СП-1.60



барьер СП-1.61

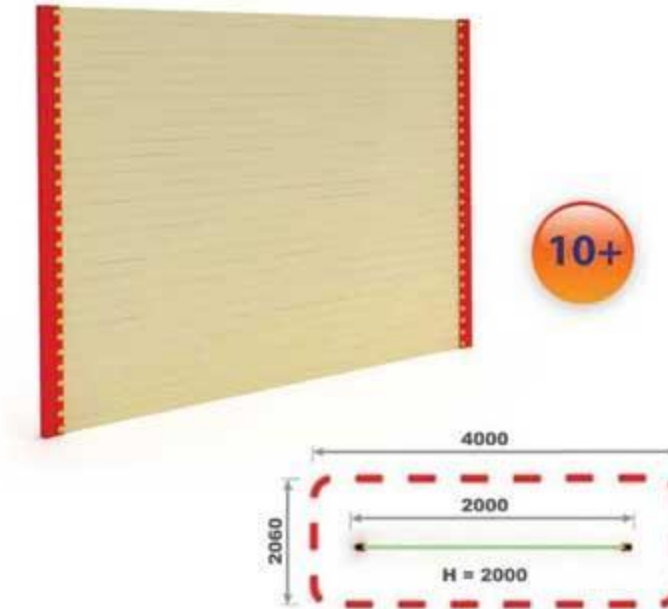

ШС-1.4 "Домик"



ШС-1.4А "Зиг-заг"

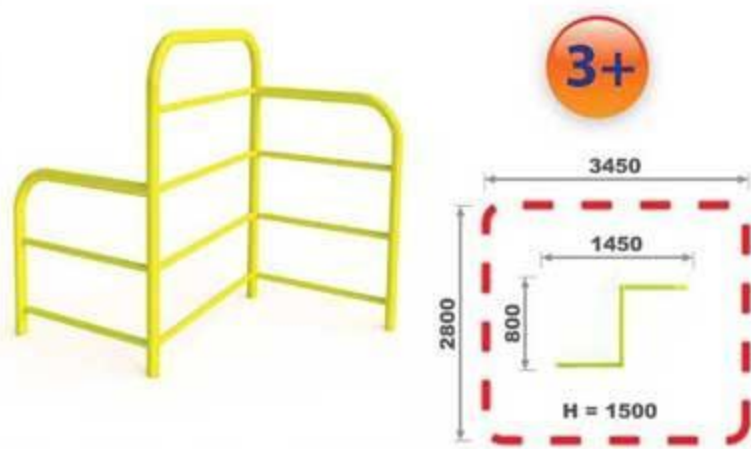

барьер СП-1.62

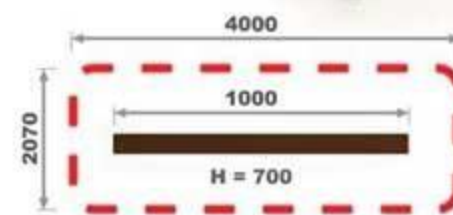

барьер СП-1.63

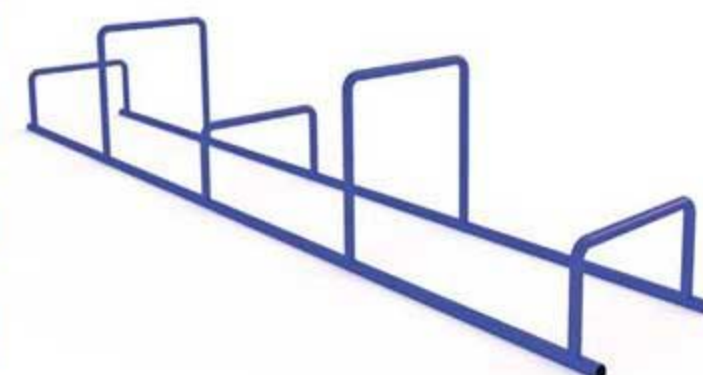

ШС-1.4Б "Радуга"

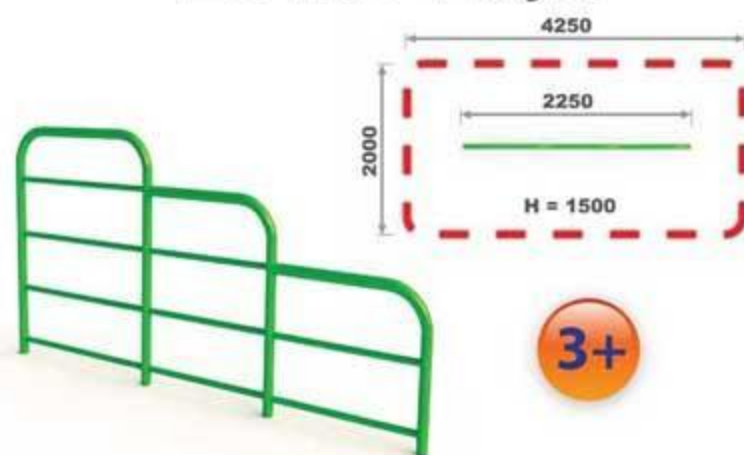

ШС-1.4В "Росток"

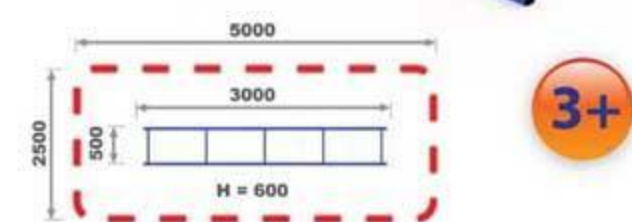
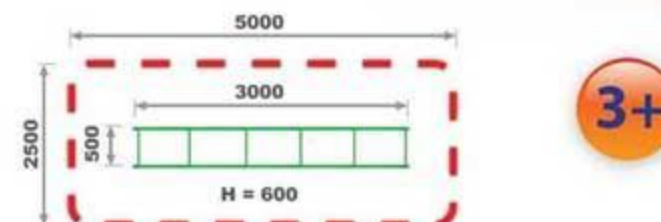



брусья СП-1.1 "Жук"

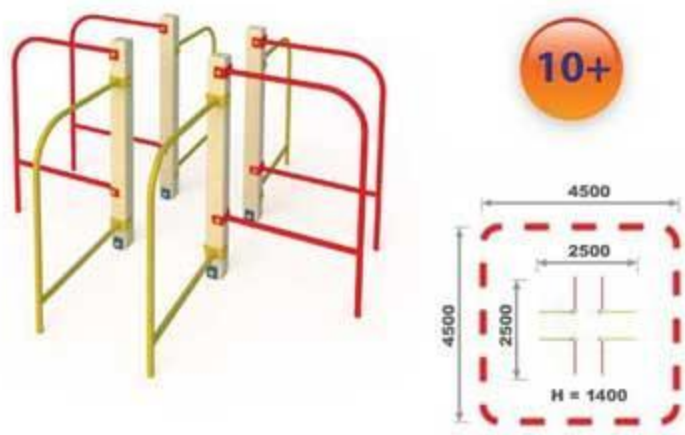

СП-1.10 "Разноуровневый"

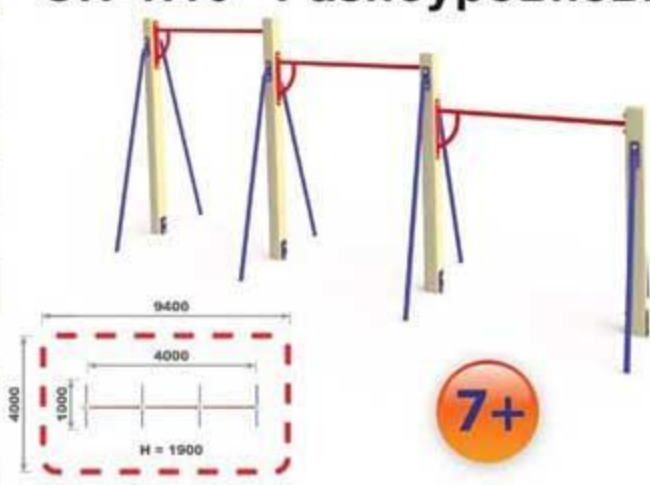

брусья СП-1.81

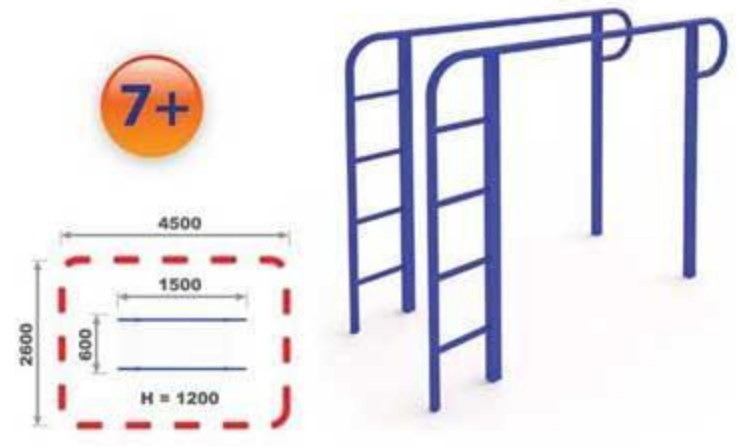

брусья СП-1.82

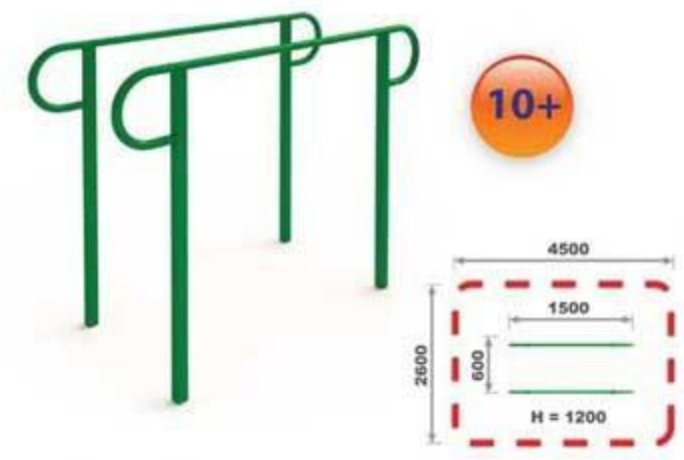

СП-1.46 "Семейный"



СП-1.47 "Трио"

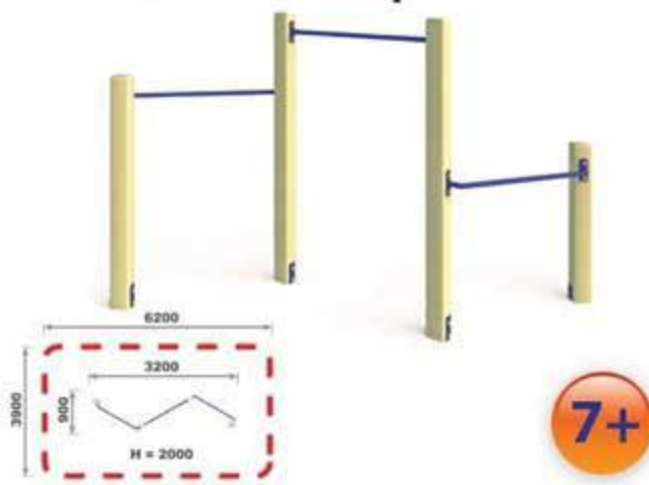

СП-1.4 "Канат"



СП-1.6 "Ромашка"



СП-1.50

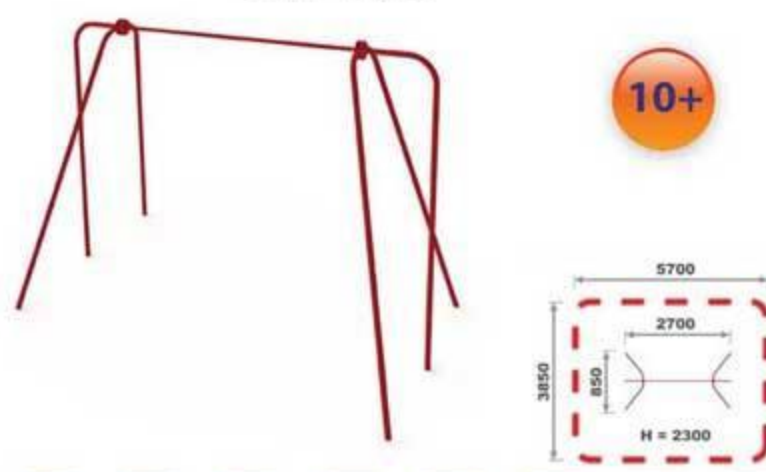

СП-1.51 "Кольца"

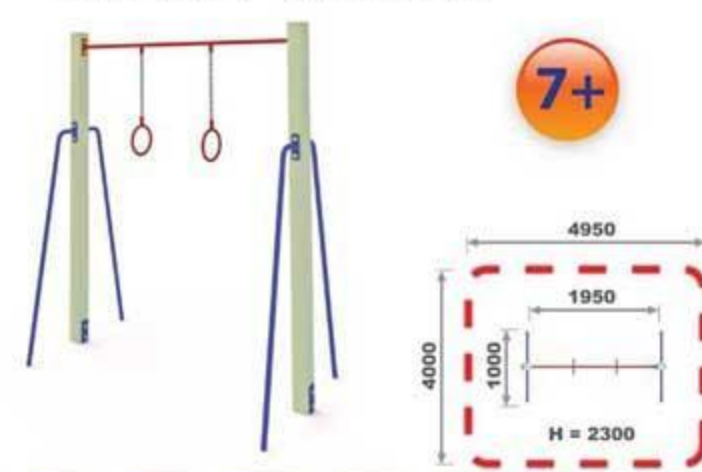

СП-1.8 "Прибрежный"



комплекс СП-1.18



СП-1.71 "Разноуровневый"

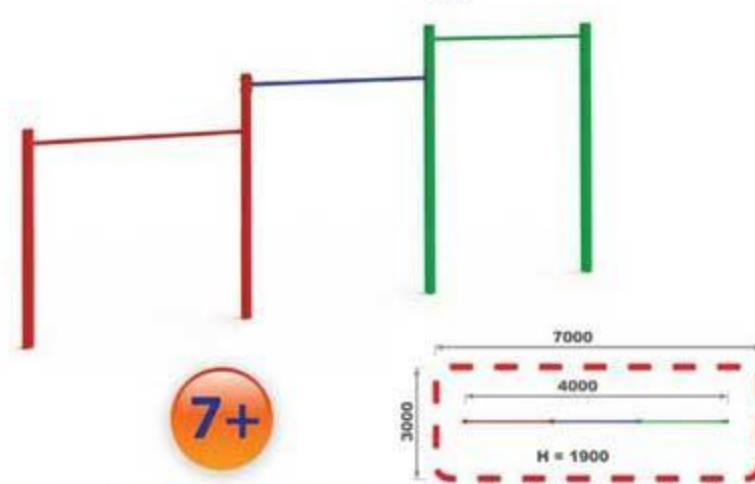

СП-1.72

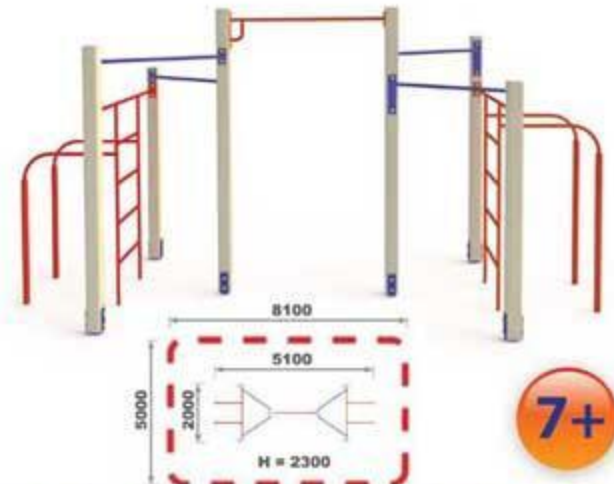



комплекс СП-1.18А



комплекс СП-1.23

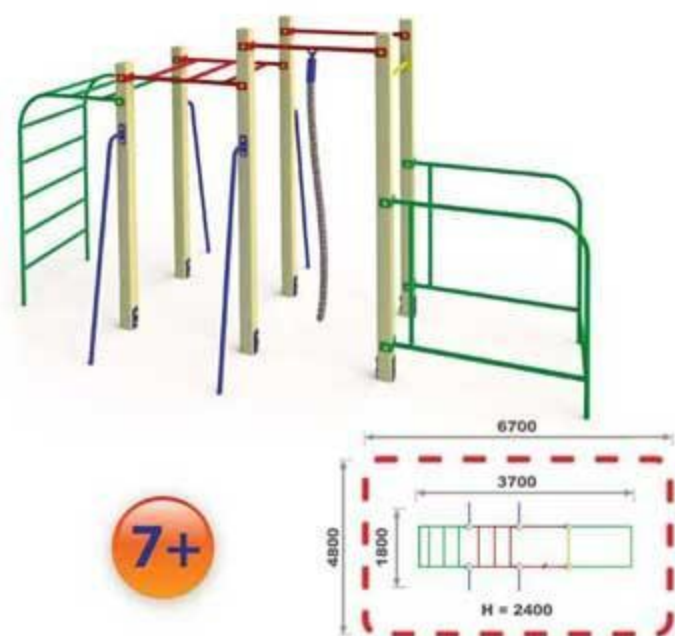

комплекс СП-1.103



комплекс СП-1.105



комплекс СП-1.53



СП-1.58 "Паутинка"

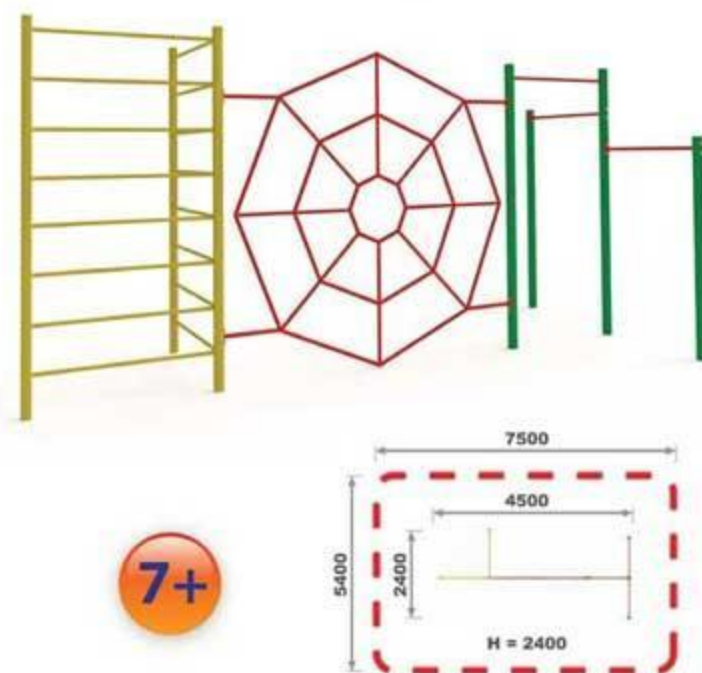

комплекс СП-1.104



комплекс СП-1.101



комплекс СП-1.102



СП-1.2 "Для упражнений на пресс"

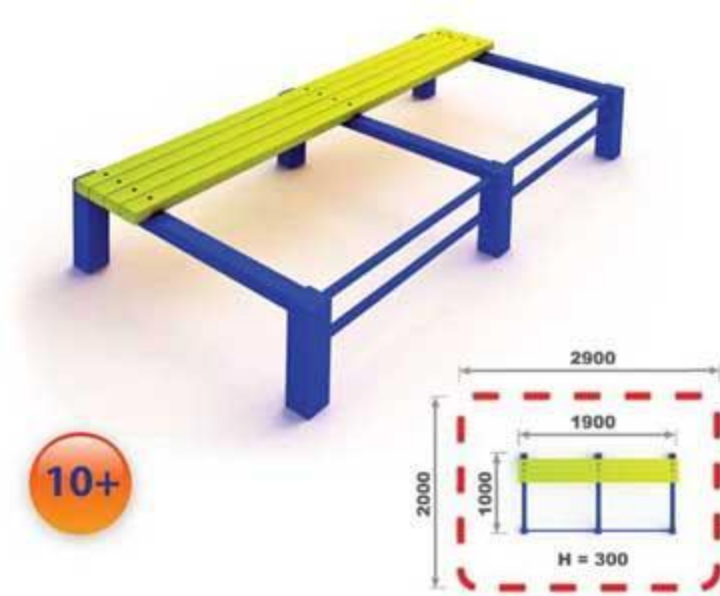

СП-1.3 "Для упражнений на пресс"





СП-1.37 "Жим лежа"

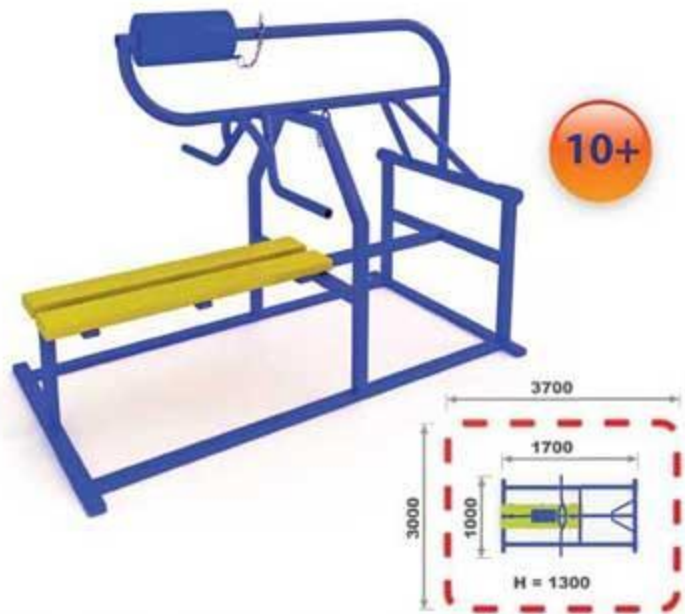

10+

СП-1.38 "Жим сидя"

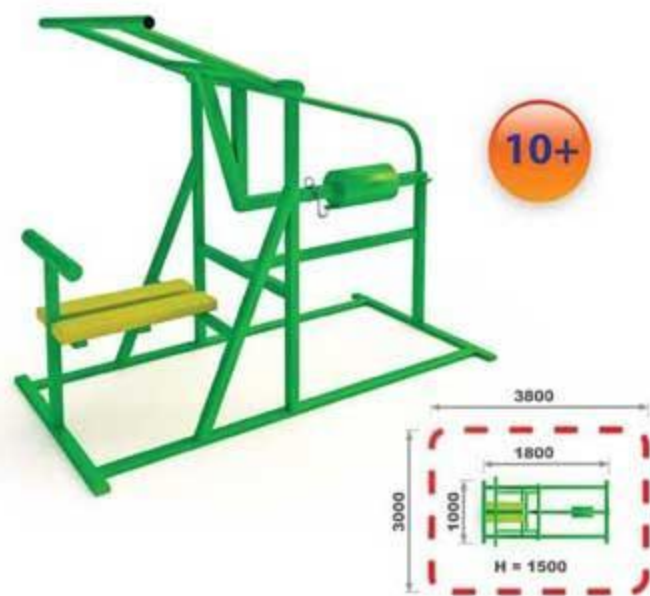

10+

тренажер "Жим к груди"  
CO-3 1 64 00



10+

тренажер "Жим на брусьях"  
CO-3 1 72 00



10+

СП-1.40 "Силач"

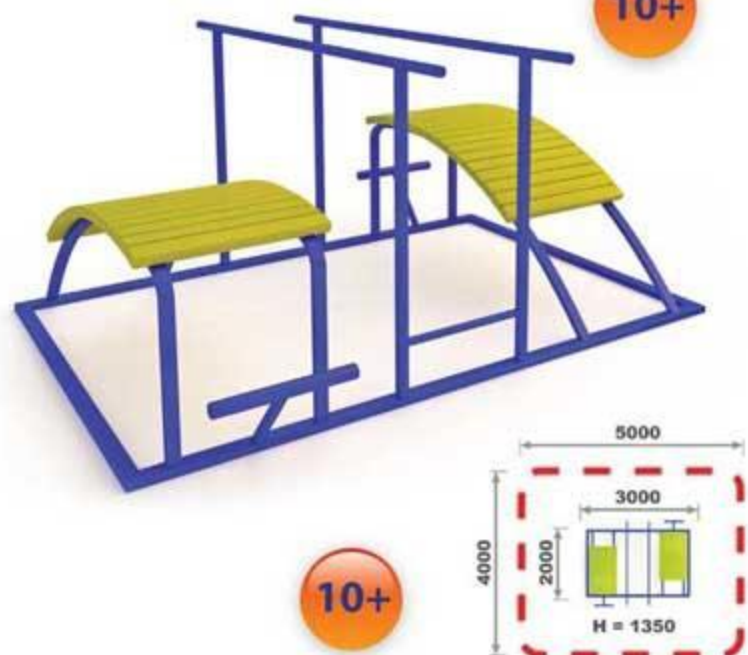

10+

10+

СП-1.42 "Стальной пресс"

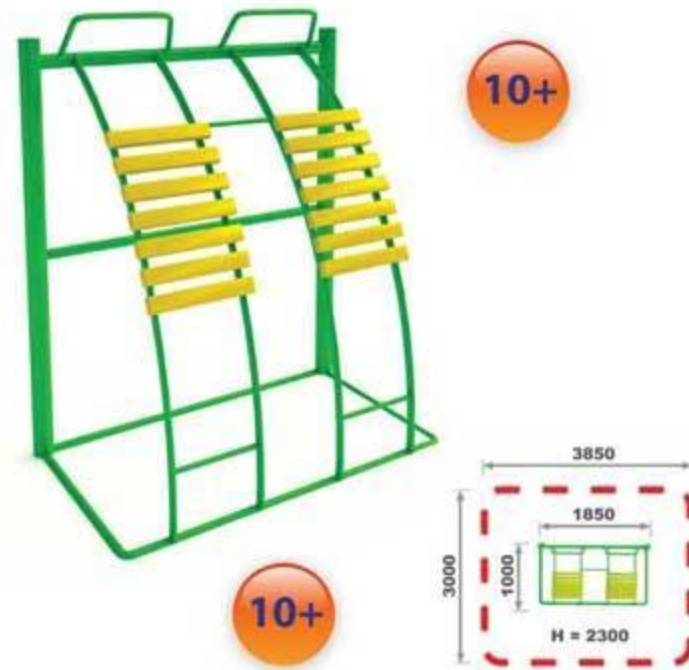

10+

10+

тренажер "Жим ногами"  
CO-3 1 65 00



10+

тренажер "Гребля"  
CO-3 1 61 00



10+

тренажер  
"Маятниковый"  
CO-3 1 66 00

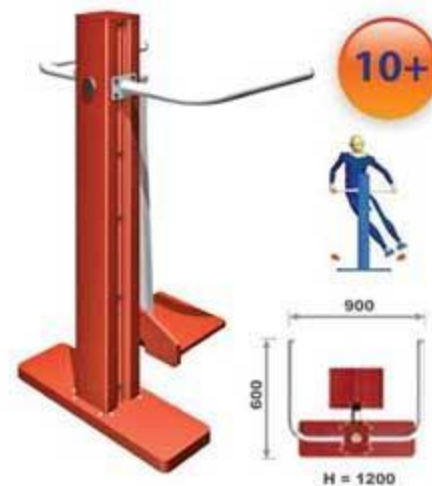

10+

тренажер  
"Жим от груди"  
CO-3 1 63 00



10+

тренажер  
"Верхняя тяга"  
CO-3 1 62 00



10+

тренажер  
"Эллиптический"  
CO-3 1 67 00

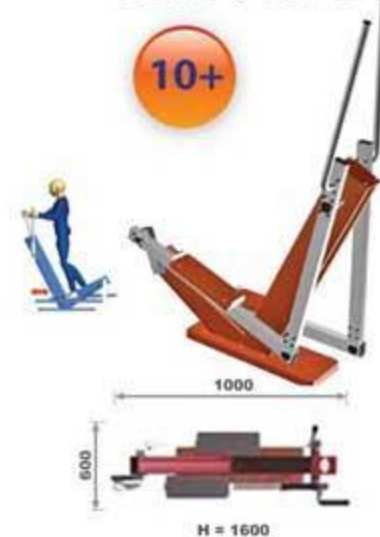

10+

тренажер  
"Круговых движений"  
CO-3 1 70 00

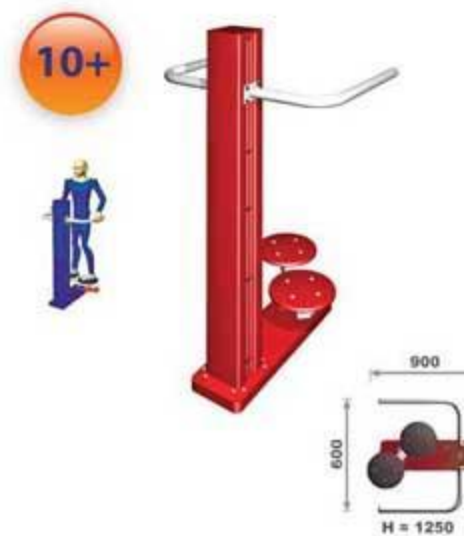

10+

тренажер  
"Шаговый"  
CO-3 1 68 00

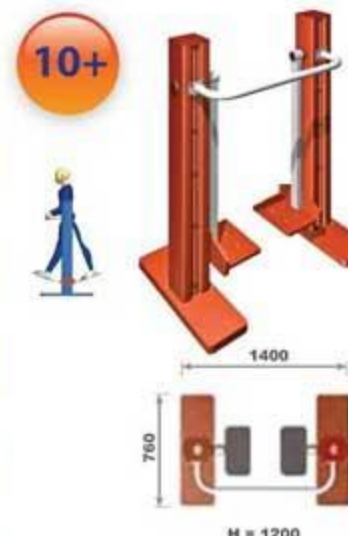

10+



СП-1.11 "Волейбольные стойки"

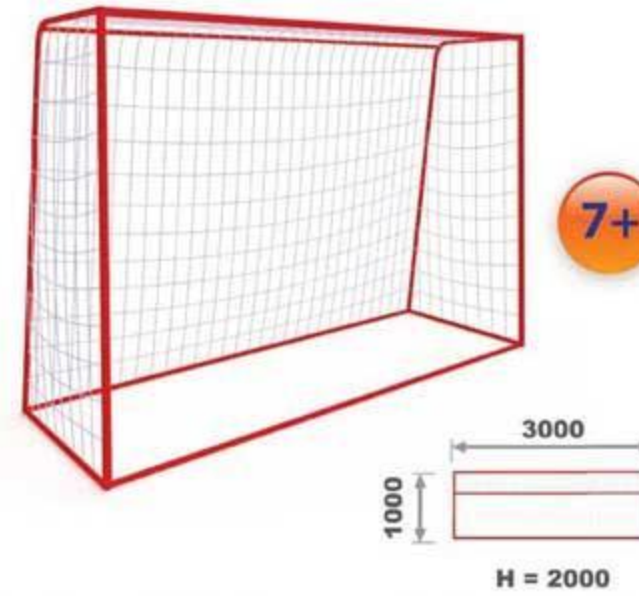
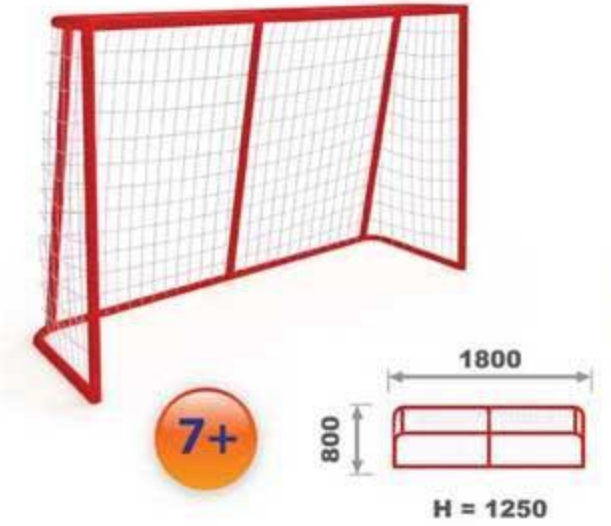

СП-1.19 "Теннисный стол"

СП-1.56  
"Ворота для мини футбола"СП-1.57  
"Ворота для хоккея"

СП-1.20 "Теннисный стол разборный"

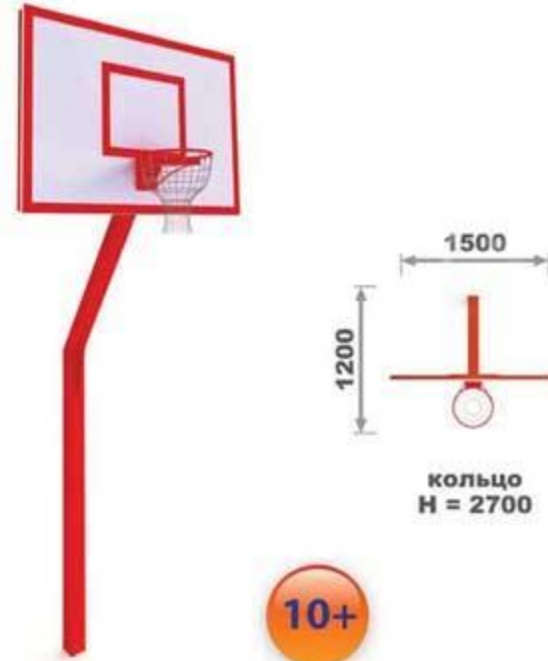
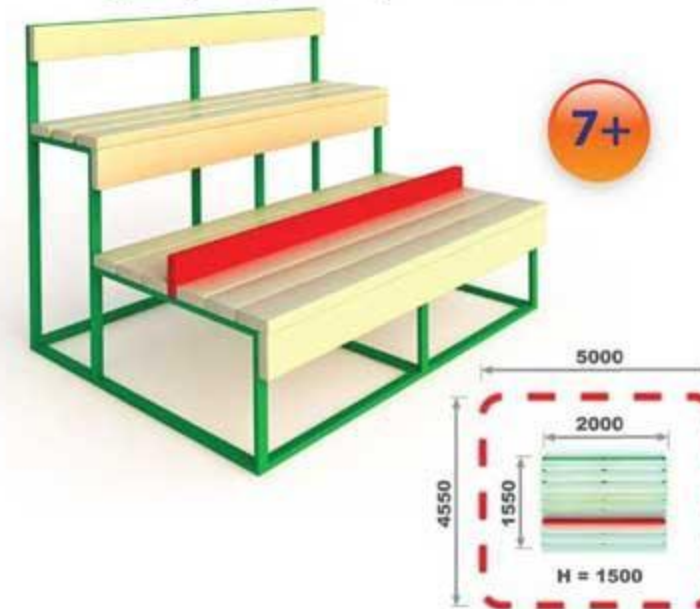

СП-1.31 "Баскетбольная стойка"

СП-1.21  
"Трибуна универсальная"СП-1.52  
"Судейское кресло"

СП-1.32 "Баскетбольная стойка"



СП-1.11 "Призёр"





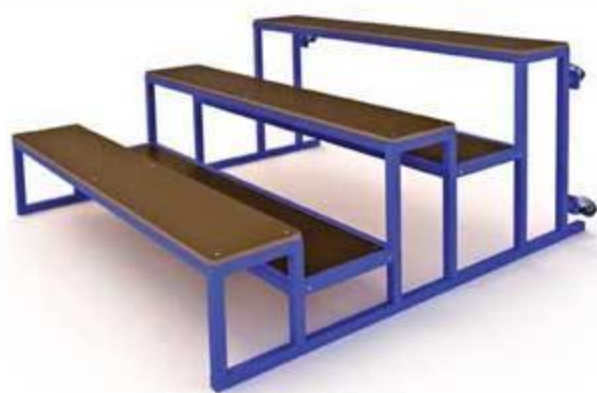

трибуна Т-1.1

2000x2000  
H=1000

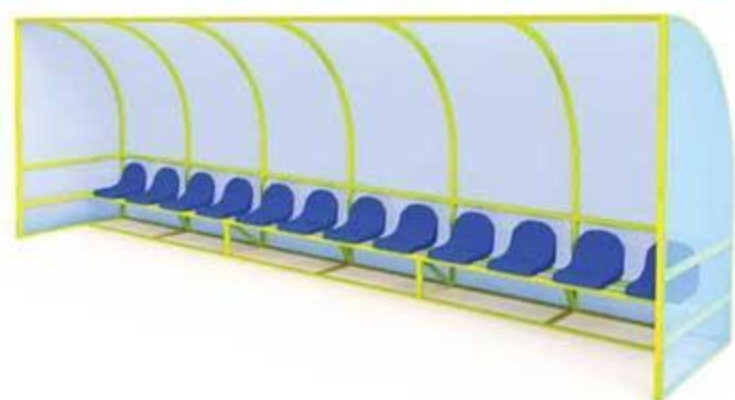

трибуна Т-1.2

6300x1200  
H=2100



трибуна Т-1.3

6200x3000  
H=1400



трибуна Т-1.4

6300x2800  
H=3300



трибуна Т-1.5

6000x2000  
H=3100

ВЕЛО-1.1

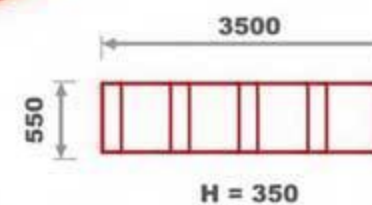

ВЕЛО-1.5

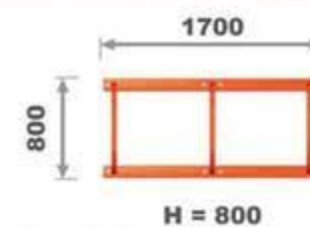

ВЕЛО-1.9

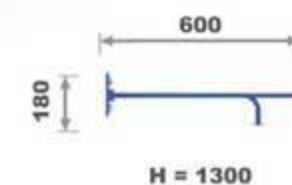
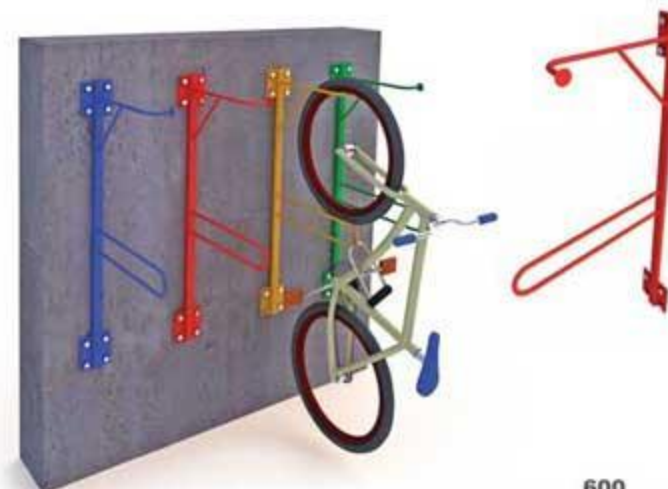

ВЕЛО-1.4

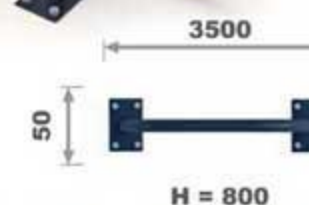

ВЕЛО-1.8



ВЕЛО-1.10

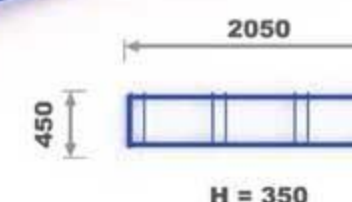



МФ-1.45 "Навес для мусорных баков"



2 контейнера

урна У-1.4



АРКА-1.1 "Лесенка"

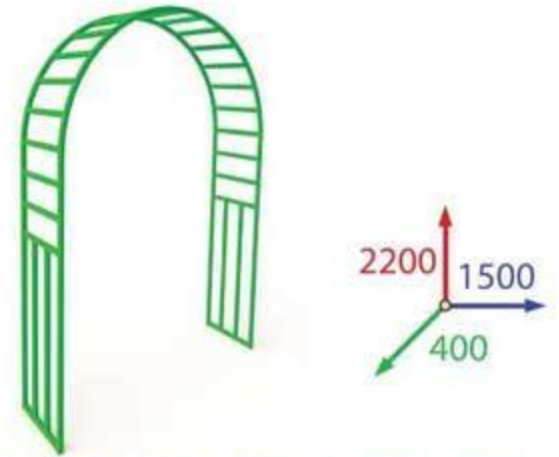

цветочница ЦМ-1.1

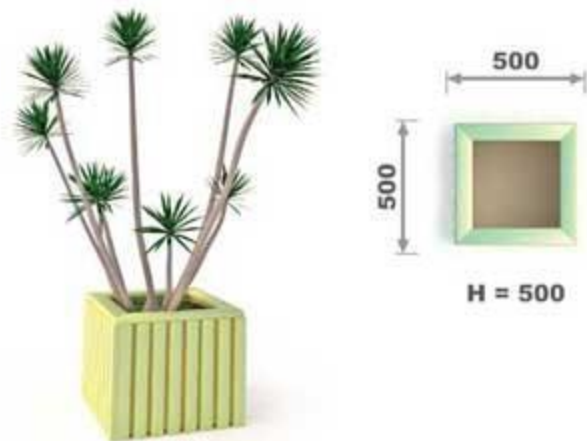

урна У-1.1



урна У-1.5



АРКА-1.2 "Орнамент"

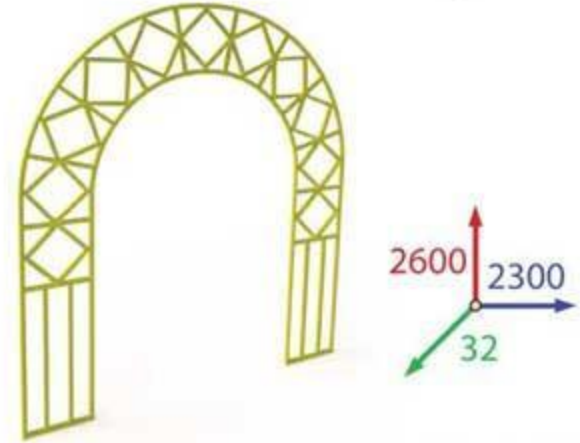

цветочница ЦМ-1.3

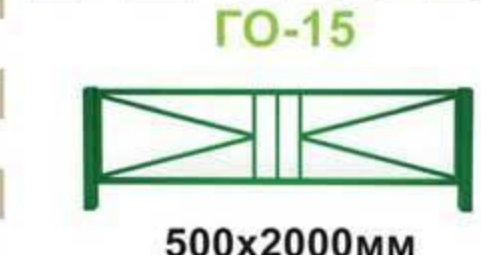
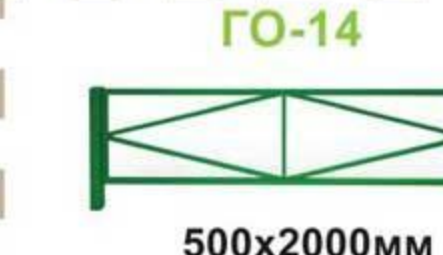
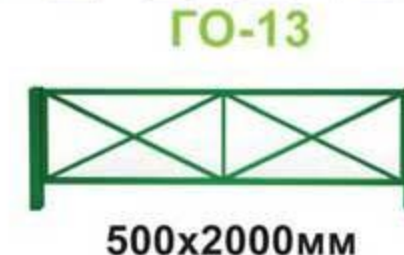
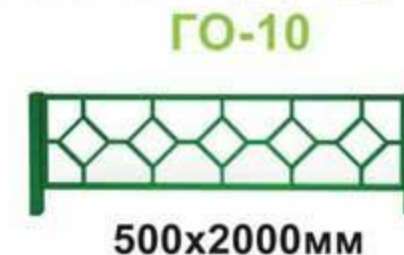
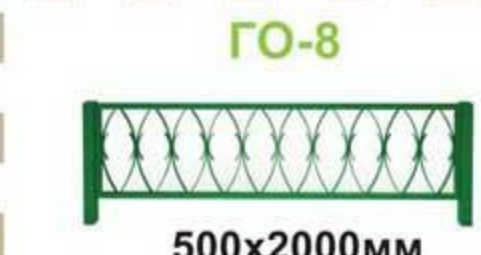
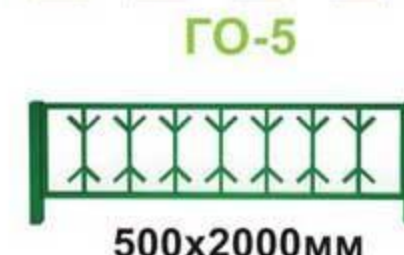
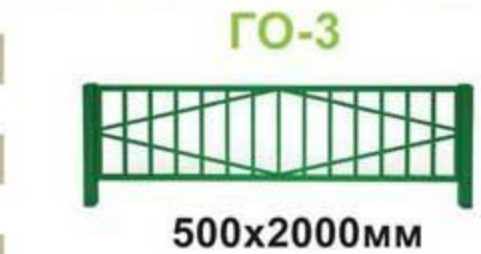
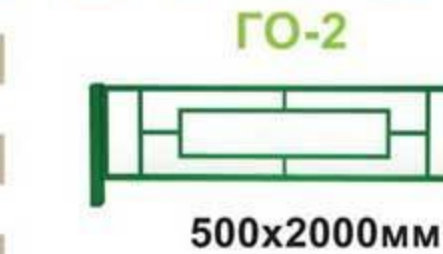
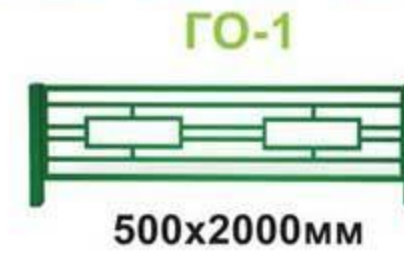
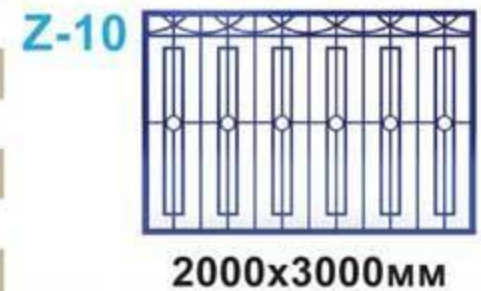
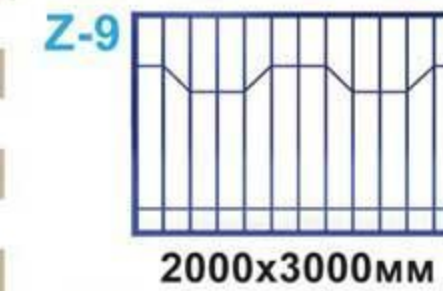
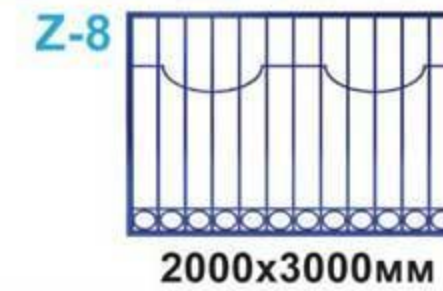
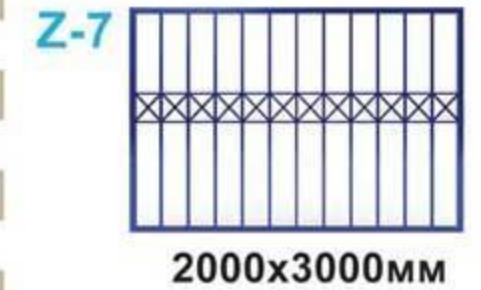
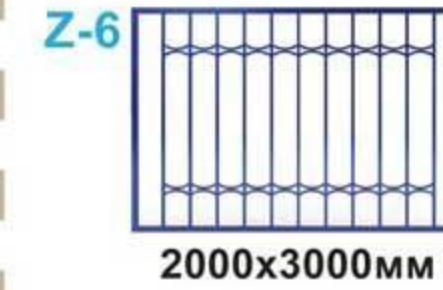
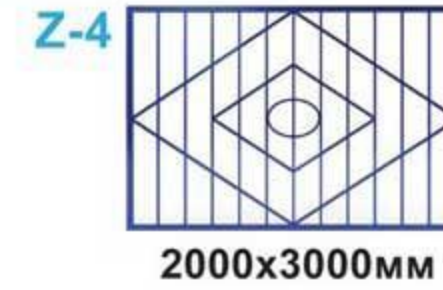
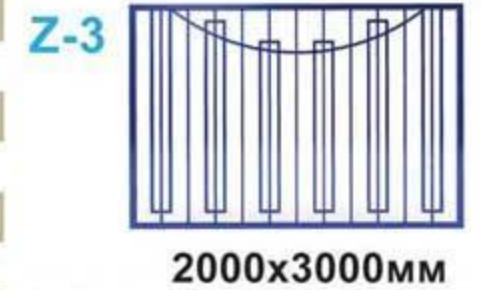
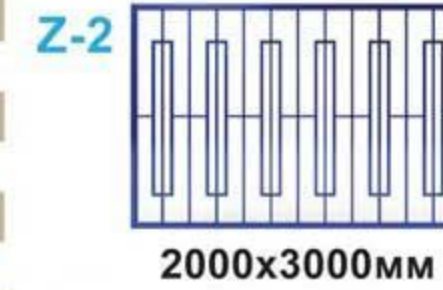
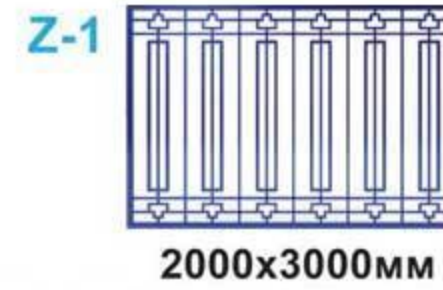
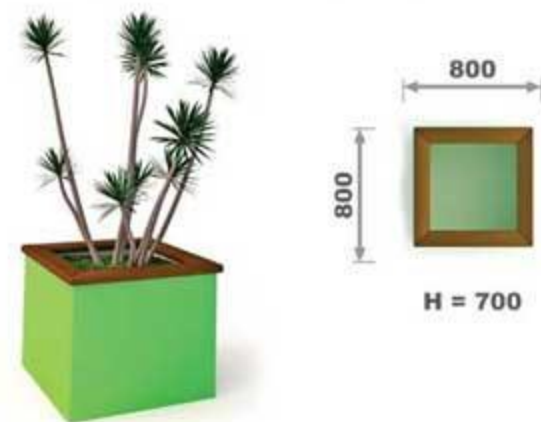



**Д ДИВАНЫ ПАРКОВЫЕ**

диван парковый **Д-1.11**

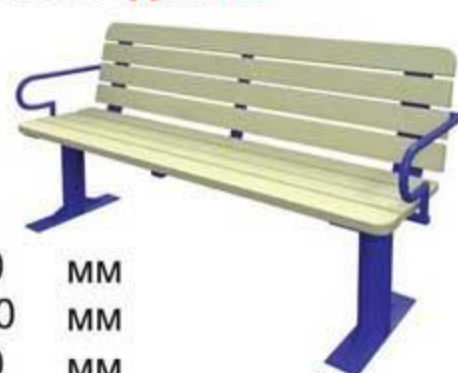

В 850 ММ  
Ш 1800 ММ  
Г 600 ММ

диван парковый **Д-1.16**

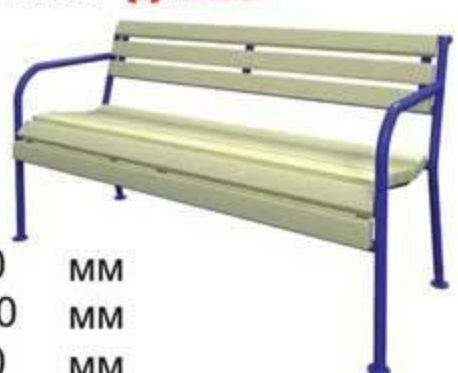

В 850 ММ  
Ш 1500 ММ  
Г 650 ММ

диван парковый **Д-1.18**



В 900 ММ  
Ш 1800 ММ  
Г 800 ММ

диван парковый **Д-1.21**



В 790 ММ  
Ш 2000 ММ  
Г 550 ММ

диван парковый **Д-1.24**

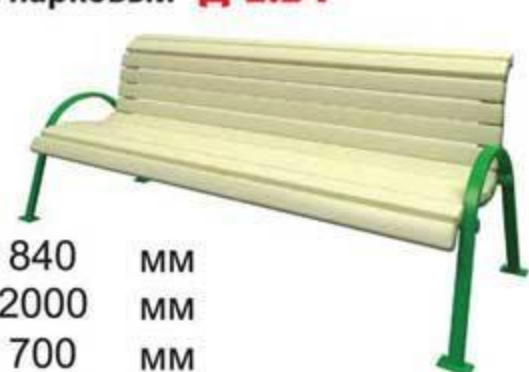

В 840 ММ  
Ш 2000 ММ  
Г 700 ММ

диван парковый **Д-1.13**

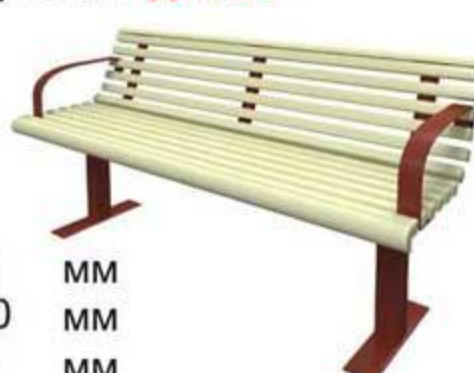

В 880 ММ  
Ш 1800 ММ  
Г 650 ММ

диван парковый **Д-1.17**

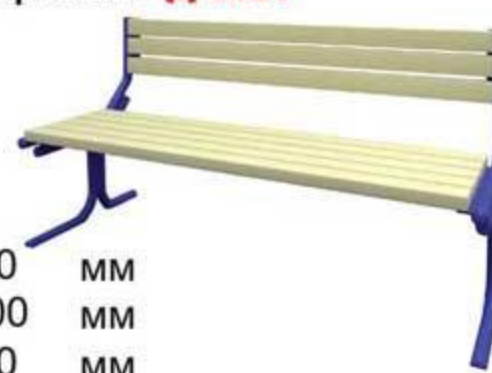

В 800 ММ  
Ш 1600 ММ  
Г 600 ММ

диван парковый **Д-1.19**



В 830 ММ  
Ш 2000 ММ  
Г 500 ММ

диван парковый **Д-1.23**



В 790 ММ  
Ш 2000 ММ  
Г 600 ММ

диван парковый **Д-1.25**



В 840 ММ  
Ш 2000 ММ  
Г 700 ММ

скамья парковая **С-1.1**

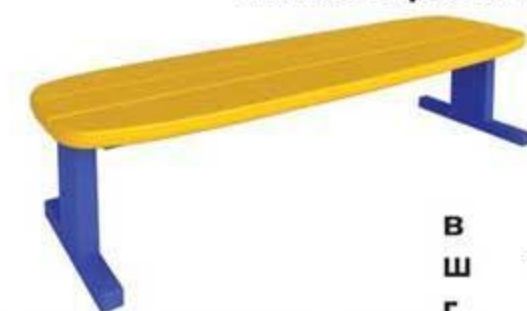

В 420 ММ  
Ш 1700 ММ  
Г 420 ММ

скамья парковая **С-1.4**



В 420 ММ  
Ш 1800 ММ  
Г 650 ММ

скамья парковая **С-1.12**



В 440 ММ  
Ш 3000 ММ  
Г 3000 ММ

скамья парковая **С-1.14**



В 440 ММ  
Ш 2150 ММ  
Г 2150 ММ

скамья парковая **С-1.18**



В 440 ММ  
Ш 2260 ММ  
Г 2260 ММ

скамья парковая **С-1.23**



В 440 ММ  
Ш 4000 ММ  
Г 500 ММ

скамья парковая **С-1.3**

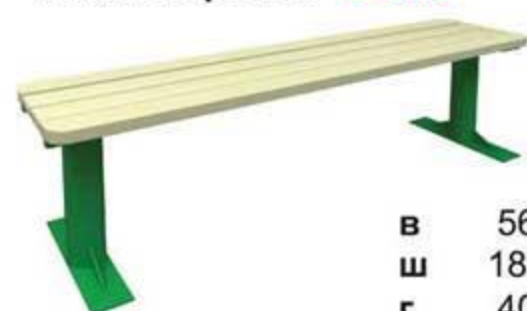

В 560 ММ  
Ш 1800 ММ  
Г 400 ММ

скамья парковая **С-1.9**

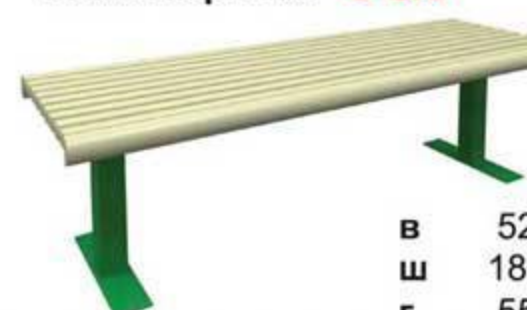

В 520 ММ  
Ш 1800 ММ  
Г 550 ММ

скамья парковая **С-1.13**



В 440 ММ  
Ш 3000 ММ  
Г 3000 ММ

скамья парковая **С-1.15**

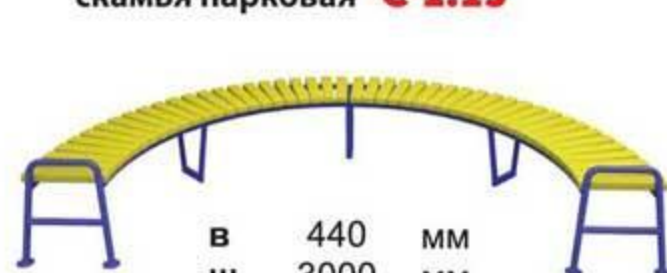

В 440 ММ  
Ш 3000 ММ  
Г 1500 ММ

скамья парковая **С-1.19**



В 440 ММ  
Ш 2300 ММ  
Г 350 ММ

скамья парковая **С-1.24**



В 500 ММ  
Ш 2000 ММ  
Г 500 ММ

**С СКАМЕЙКИ ПАРКОВЫЕ**



**Combi Pipe II**

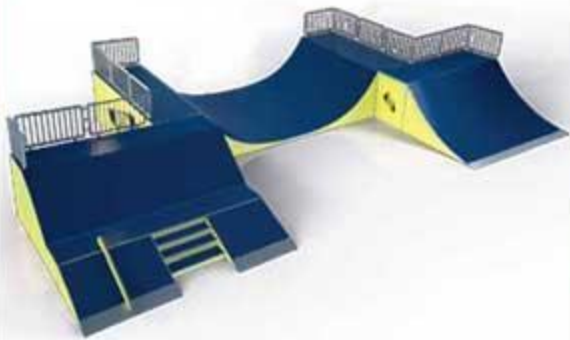

длина	ширина	высота
14,20	8,30	0,90
-,-	-,-	1,25

**Half Pipe**



длина	ширина	высота
13,50	7,20	3,45

**Skate Canyon**

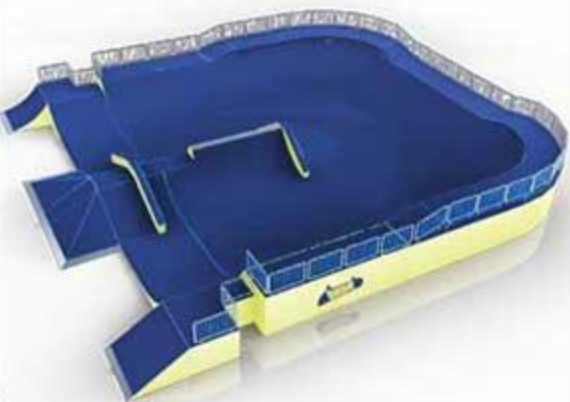

длина	ширина	высота
21,70	15,50	0,90\1,25
-,-	-,-	1,50\1,80

**Midi Pipe**



длина	ширина	высота
10,50	3,60	1,80
10,50	4,80	1,80

**Fun Pipe V12**



длина	ширина	высота
21,70	11,70	0,90\1,25
-,-	-,-	1,50\1,80

**Competition Pipe with Channel and Roll-In**



длина	ширина	высота
14,50	9,60	3,90
-,-	-,-	4,90

**ОБОРУДОВАНИЕ ДЛЯ СКЕЙТ - ПАРКОВ**

производится только из высоко качественных и высокопрочных материалов. Все металлические конструкции окрашены полимерным порошковым покрытием, это придаёт изделиям высокую стойкость к воздействию атмосферных осадков и безупречный вид.

Металлический каркас оборудования, в зависимости от пожеланий заказчика, обшивается полностью или частично. Для рабочего покрытия могут использоваться следующие материалы:

- 1. Армированные стекловолокном пластиковые панели.** Материал имеющий многослойную структуру из высокопрочных и шумоизолирующих материалов. Устойчив к воздействию атмосферных осадков.
- 2. Высококачественная нержавеющая сталь.** Данное покрытие обладает чрезвычайной прочностью, демонстрируя превосходную защиту от вандализма, а так же обладает хорошей шумоизоляцией.
- 3. Высококачественная влагостойкая фанера.** Материал обладающий всеми необходимыми для скейт-парка качествами. Хорошо зарекомендовал себя при использовании в крытых помещениях.

